

alea

art | ö  
Portfolio

portfolio

portfolio #2



portfolio #2

台灣總代理

**STYLE**  
SYSTEM FURNITURE

Tel: 02-2659-1799 FAX:02-2659-7007

地址：台北市內湖區瑞湖街158號B1

Web : [www.stylegroup-inc.com](http://www.stylegroup-inc.com)

Facebook : Style Furniture 世代家具

# In- dex

12

**Direzionali**

Executive  
Mobilier de direction  
Ejecutivos

78

**Operativi**

Workstations  
Systèmes  
Operativos

162

**Reception**

Receptions  
Accueils  
Recepciones

178

**Complementi**

Complements  
Compléments  
Complementos

204

**Librerie**

Bookcases  
Bibliothèques  
Libreros

220

**Contenitori**

Storage  
Rangements  
Contenedores

254

**Accessori**

Accessories  
Accessoires  
Accesorios

260

**Spazio**

Space  
Espace  
Espacio

284

**Materiali+finiture**

Materials+finishes  
Matériels+finitions  
Materiales+acabados



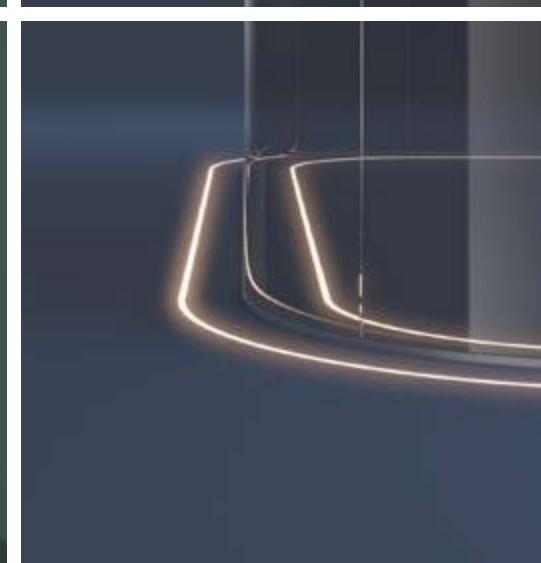
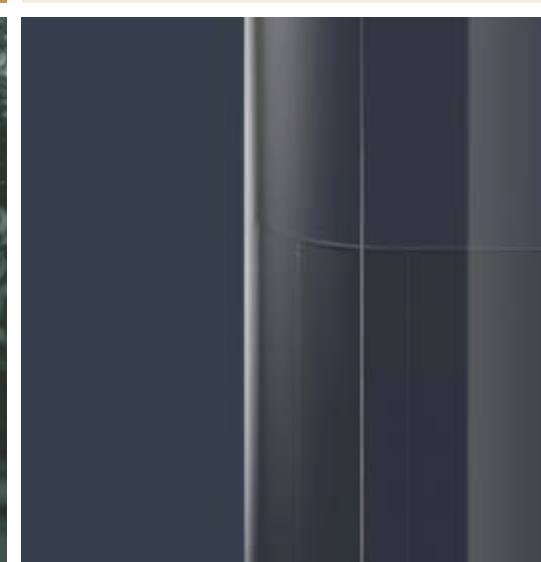
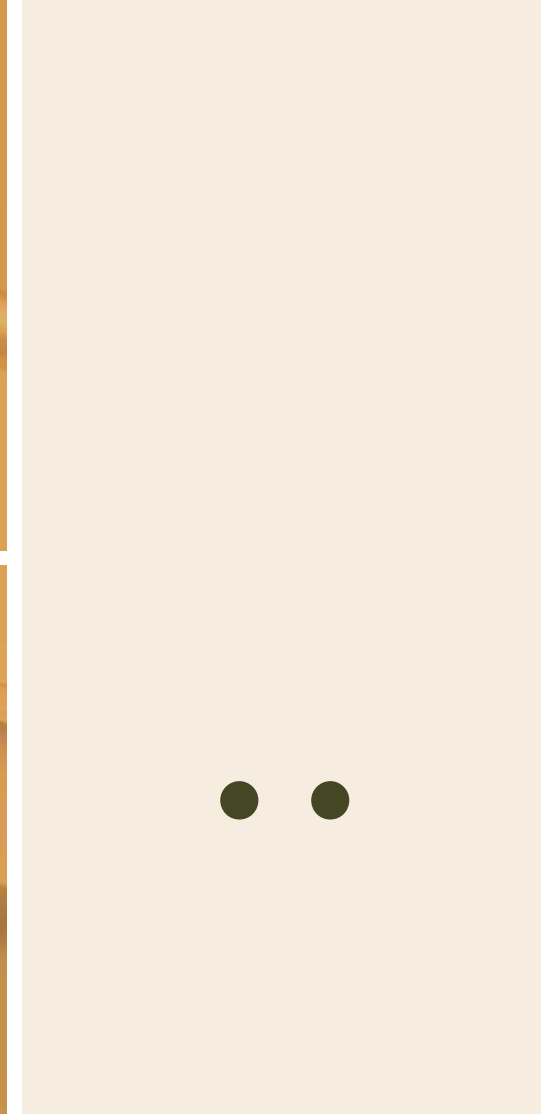
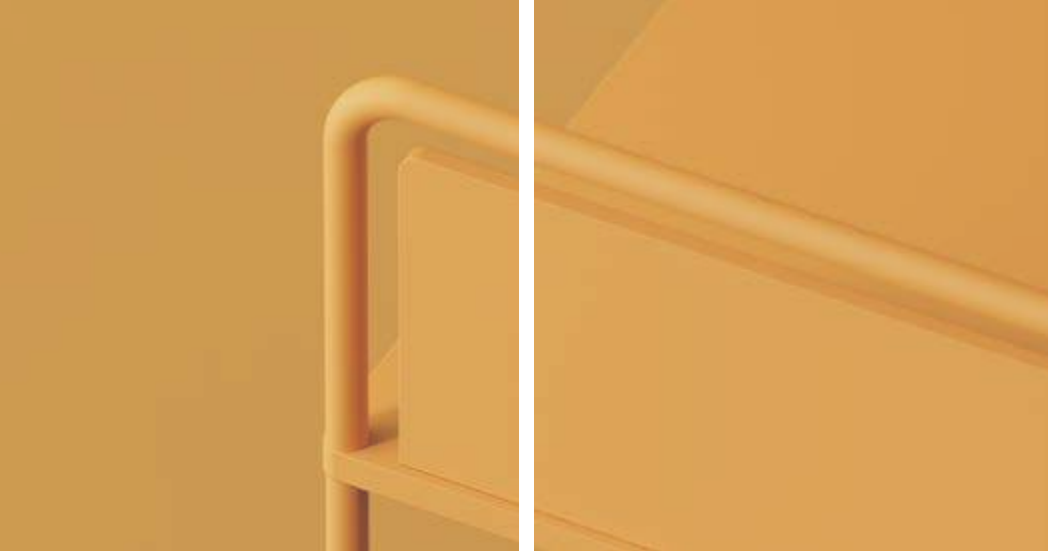



Fondata nel 1972, Alea è diventata una delle aziende specializzate nell'arredamento per ufficio maggiormente attive sul mercato internazionale. La nostra mission è quella di arredare gli spazi lavorativi con soluzioni belle, confortevoli e stimolanti. Luoghi dove le persone si sentono bene. Proponiamo infatti una ampia gamma di prodotti di alta qualità, dai direzionali alle workstation, dalle reception ai contenitori, tutti caratterizzati da una attenta ricerca di design e materiali.

Oltre ai prodotti di serie, possiamo offrire soluzioni appositamente studiate per venire incontro alle specifiche richieste della nostra clientela.

Founded in 1972, Alea has become one of the most active office furniture companies globally. Our mission is to furnish work spaces with beautiful, comfortable and stimulating solutions. Places where people feel good. In fact, we offer a wide range of high quality products, from management to workstations, from reception to storage units, all characterized by a careful research of design and materials.

In addition to standard products, we can offer solutions designed to meet the specific requirements of our customers.

Fondée en 1972, Alea est devenue l'une des entreprises de mobilier à usage professionnel les plus actives sur le marché international. Notre mission est de meubler les espaces de travail avec des belles solutions autant que confortables et stimulantes. Des lieux où les gens se sentent bien. En effet, nous offrons une large gamme de produits de haute qualité, à partir de bureaux directionnels, bureaux simples et bench, jusqu'à banque d'accueil et rangements, tous caractérisés par une recherche minutieuse du design et des matériaux.

En plus des produits standard, nous pouvons proposer des solutions conçues expressément pour répondre aux exigences spécifiques de nos clients.

Fundada en 1972, Alea se ha convertido en una de las empresas de muebles de oficina más activas en el mercado internacional. Nuestra misión es amueblar los espacios de trabajo con soluciones bellas, cómodas y estimulantes. Lugares donde la gente se siente bien. De hecho, ofrecemos una amplia gama de productos de alta calidad, desde oficinas ejecutivas hasta estaciones de trabajo, desde la recepción hasta unidades de almacenamiento, todo ello caracterizado por una cuidadosa investigación de diseño y materiales.

Además de los productos estándar, podemos ofrecer soluciones específicamente diseñadas para satisfacer los requisitos específicos de nuestros clientes.

# INDUSTRIAL ARTISANS

La nostra mission è creare ambienti di lavoro belli, confortevoli e stimolanti. Luoghi dove le persone si sentono bene.

Our mission is to create beautiful, comfortable and inspiring office environments. Places where people feel good.  
Notre mission est de créer des beaux espaces de travail, autant que confortables et stimulants. Des lieux où les gens se sentent à l'aise.

Nuestra misión es crear ambientes de trabajo bellos, cómodos y estimulantes. Lugares donde la gente se siente bien.

## 100%

Lavoriamo con un network strutturato di fornitori locali. I nostri prodotti sono 100% made in Italy.

We work with a strong network of local suppliers. Our products are 100% made in Italy.  
Nous travaillons avec un réseau structuré de fournisseurs locaux. Nos produits sont fabriqués 100% en Italie.  
Trabajamos con una red estructurada de proveedores locales. Nuestros productos son 100% made in Italy.

# JUST IN TIME

La nostra produzione è basata sul sistema "just in time", la quale ci permette di offrire un'ampia gamma di prodotti riducendo al minimo gli sprechi.

Our production is based on a "just in time" system that allows us to offer a wide range of products while minimising waste.

Notre production est basée sur un système de "just in time" qui nous permet d'offrir une large gamme de produits tout en minimisant les déchets.

Nuestra producción se basa en un sistema "justo a tiempo" que nos permite ofrecer una amplia gama de productos minimizando los residuos.

## 90+

Siamo presenti in più di 90 paesi nel mondo.

We are present in more than 90 countries worldwide.  
Nous sommes présents dans plus de 90 pays dans le monde.  
Estamos presentes en más de 90 países del mundo.



Alea crede fermamente nel business sostenibile e nell'attenzione sull'impatto ambientale e sulla salute dei lavoratori. Il perseguimento di questi principi porta la nostra azienda a focalizzare gli sforzi sullo sviluppo eco-compatibile dei processi produttivi e dei prodotti finali. Infatti una delle nostre priorità è proprio la ricerca costante per l'utilizzo di materiali riciclabili.

Il conglomerato ligneo che viene impiegato per la produzione dei pannelli, rientra nella classe CARB P2 per le basse emissioni di formaldeide.

Le pareti divisorie e le porte possono contribuire al conseguimento del punteggio di certificazione LEED® V4 NC New Construction e LEED® V4 CI Commercial Interior per i seguenti crediti:

- Divulgazione e ottimizzazione dei prodotti edilizi, Approvvigionamento di materie prime
- Gestione dei rifiuti da costruzione e demolizione
- Riduzione dell'impatto del ciclo di vita degli interni (LEED ID+C)
- Materiali a bassa emissione
- Luce diurna
- Prestazioni acustiche.

Alea ha certificato il suo processo di qualità, in accordo con lo standard UNI EN ISO 9001 ed ha ottenuto il certificato UNI EN ISO 14001 per la gestione ambientale. Abbiamo inoltre certificato il sistema di gestione per la salute e la sicurezza in conformità alla UNI ISO 45001.

Su richiesta del cliente, Alea può fornire prodotti certificati FSC® (License Code FSC-C118323) secondo lo standard FSC-STD-40-004.

Sempre attenta alle iniziative ambientali, Alea garantisce per i suoi imballaggi l'utilizzo di cartone riciclato al 88% (marchiato Ecopack) e l'impiego di materiali riciclabili.



Alea cree firmemente en el negocio sostenible y en la atención sobre el impacto medioambiental y la salud de los trabajadores. La persecución de estos principios lleva nuestra empresa a centrar los esfuerzos en el desarrollo ecológico de los procesos de producción y de los productos finales. De hecho, una de nuestras prioridades es la investigación constante sobre el uso de materiales reciclables.

El conglomerado de madera que se utiliza para la producción de los paneles se clasifica en la clase P2 de CARB por sus bajas emisiones de formaldehído.

Las paredes divisorias y las puertas pueden contribuir a la puntuación de la certificación LEED® V4 NC New Construction y LEED® V4 CI Commercial Interior para los siguientes créditos:

- Divulgación y optimización de los productos de construcción, Adquisición de materias primas
- Gestión de residuos de construcción y demolición
- Reducción del impacto del ciclo de vida de los interiores (LEED ID+C)
- Materiales de baja emisión
- Luz diurna
- Rendimiento acústico.

Alea ha certificado su proceso de calidad según la norma UNI EN ISO 9001 y ha obtenido el certificado UNI EN ISO 14001 de gestión medioambiental. Además, hemos certificado nuestro sistema de gestión de la salud y la seguridad conforme a la norma UNI ISO 45001.

A petición del cliente, Alea puede suministrar productos certificados FSC® (código de licencia FSC-C118323) de acuerdo con la norma FSC-STD-40-004.

Siempre atenta a las iniciativas medioambientales, Alea garantiza para sus embalajes el uso de un 88% de cartón reciclado (marchado Ecopack) y la utilización de materiales reciclables.

Alea firmly believes in sustainable business and a focus on environmental impact and workers' health. The pursuit of these principles leads our company to focus its efforts on the eco-friendly development of production processes and end products. In fact, one of our priorities is constant research into the use of recyclable materials.

The wood conglomerate that is used for the production of the panels, falls into the CARB P2 class for low formaldehyde emissions.

The partitions and doors can contribute to the LEED® V4 NC New Construction and LEED® V4 CI Commercial Interior certification score for the following credits:

- Disclosure and optimisation of building products, Procurement of raw materials
- Construction and demolition waste management
- Reducing the life cycle impact of interiors (LEED ID+C)
- Low-emission materials
- Daylighting
- Acoustic performance.

Alea has certified its quality process according to UNI EN ISO 9001 standard and obtained UNI EN ISO 14001 certificate for environmental management. We have also certified our health and safety management system in accordance with UNI ISO 45001.

Upon customer request, Alea can supply FSC® certified products (License Code FSC-C118323) according to FSC-STD-40-004 standard.

Always attentive to environmental initiatives, Alea guarantees for its packaging the use of 88% recycled cardboard (marked Ecopack) and the use of recyclable materials.

Alea croit fermement dans une entreprise durable et porte son attention sur l'impact environnemental et la santé des travailleurs. La poursuite de ces principes conduit notre entreprise à concentrer ses efforts sur le développement éco-compatible des processus de production et des produits finaux. En fait, l'une de nos priorités est la recherche constante de l'utilisation de matériaux recyclables.

Le conglomerat de bois utilisé pour la production des panneaux appartient à la classe CARB P2 pour les faibles émissions de formaldéhyde.

Les cloisons et les portes peuvent contribuer au barème de certification LEED® V4 NC New construction et LEED® V4 CI Commercial Interior pour les crédits suivants:

- Divulgation et optimisation des produits de construction, Approvisionnement des matières premières
- Gérance des déchets de construction et de démolition
- Réduction de l'impact du cycle de vie des intérieurs (LEED ID+C)
- Matériaux à faible émission
- Lumière du jour
- Performances acoustiques.

Alea a certifié son processus de qualité, conformément à la norme UNI EN ISO 9001 et a obtenu le certificat UNI EN ISO 14001 pour la gestion environnementale. Nous avons également certifié le système de gestion de la santé et de la sécurité conformément à la norme UNI ISO 45001.

Sur demande du client, Alea peut fournir des produits certifiés FSC® (code de licence FSC-C118323), selon la norme FSC-STD-40-004.

Toujours attentive aux initiatives environnementales, Alea garantit l'utilisation de 88% de carton recyclé (marque Ecopack) et l'utilisation de matériaux recyclables pour ses emballages.

green



# direzionali

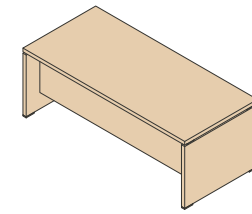

14  
Odeon

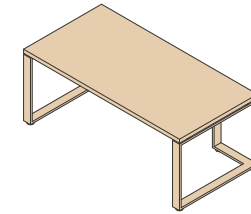

22  
Archimede

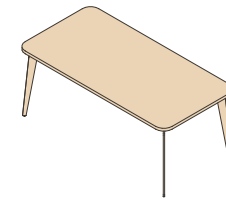

30  
Blade X

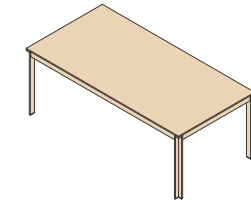

38  
Zefiro X

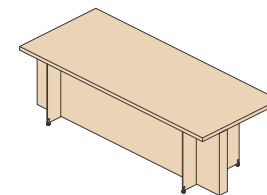

46  
Oasi

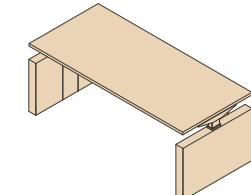

54  
Crono X

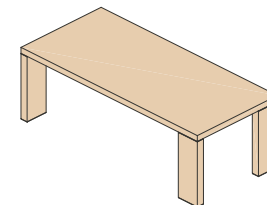

62  
Titano

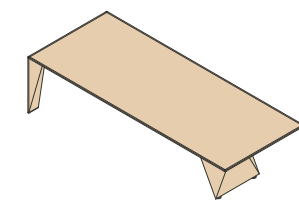

70  
Eracle



# Odeon

**Odeon è una collezione direzionale capace di armonizzare soluzioni d'arredo classiche e moderne.**

**Propone infatti diverse tipologie di scrivanie e finiture, così da offrire un'ampia gamma di soluzioni estetiche e funzionali.**

**Oltre alla scrivania con gambe pannellate e con contenitore laterale strutturale, è disponibile anche quella con gambe angolari a sezione quadrata che, con l'applicazione di passacavi, possono essere utilizzate per il transito dell'elettrificazione.**

**I piani sono disponibili in legno (essenza o melaminico) in vetro retrolaccato (anche nella versione antimpronta), cuoio e gres, incorniciati da un profilo in alluminio.**

**Molto ampia l'offerta di tavoli riunione modulari.**

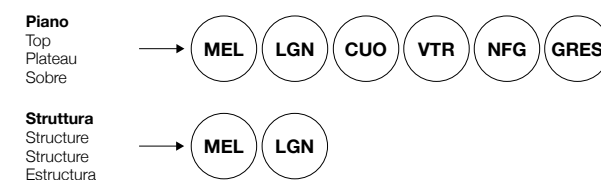

solid  
classic  
sharp

Odeon is a versatile collection that has the ability of harmonizing classic and modern furniture solutions. It offers different types of desks in various materials.

Besides the classic version with panel legs and structural side storage units, Odeon is also offered with corner legs.

A grommet can be added to the square legs so that wires can be run through.

The tops are available in wood veneer or Italian melamine, in backlacquered glass (also in the antifinger version), leather and porcelain tile, framed by an aluminium profile.

Very wide is also the choice among modular meeting tables.

Odeon est une collection exécutive capable d'harmoniser des solutions d'ameublement classiques et modernes.

En effet, elle propose différents types de bureaux et de finitions, afin d'offrir une large gamme de solutions esthétiques et fonctionnelles.

En plus du bureau avec pieds panneaux et meuble de service structurel, il y a aussi un bureau à pieds carrés. Ces piétements peuvent être utilisés comme passe-câbles, pour le transit de l'électricité.

Les plateaux sont disponibles en bois ou mélaminé, en verre rétro-laqué (également dans la version anti tâches), en cuir et en grès, encadrés par un chant aluminium.

Il existe une large gamme de tables de réunion modulaires.

Odeon es una colección ejecutiva que se integra tanto en ambientes clásicos como modernos.

De hecho propone varios modelos de escritorios y acabados, ofreciendo así una amplia gama de soluciones estéticas y funcionales.

Además del escritorio con patas paneladas y contenedor lateral estructural, también está disponible el con patas de esquinas de sección cuadrada que, con la aplicación de un pasacables, pueden usarse para el tránsito de la electrificación.

Los tableros están disponibles en madera (chapada o melamina) en vidrio retrolacado (también en la versión antihuellas), cuero y gres porcelánico, enmarcados por un perfil de aluminio.

La oferta de mesas de reunión modulares es muy amplia.



# Odeon. collection



**Uffici privati**  
Private offices  
Bureaux privés  
Oficinas privadas



**Tavolini**  
Coffee tables  
Tables basses  
Mesitas

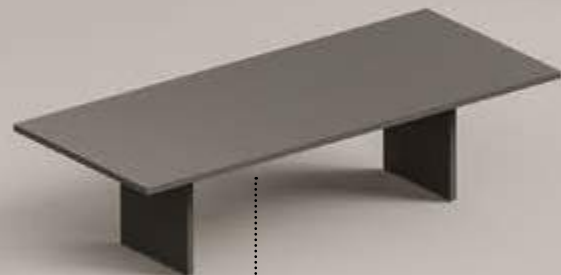

**Salè riunioni**  
Meeting rooms  
Salles de réunion  
Salas de reuniones



**Contentori**  
Storage  
Rangements  
Contenedores



1.

**1. Scrivania** | Desk | Bureau | Mesa **Fin.** RC  
L 200 P 90 cm | W 78 3/4" D 35 3/8"

**2. Tavolo** | Table | Table | Mesa **Fin.** AK, CN  
L 630 P 180 cm | W 248" D 70 7/8"

**3. Scrivania** | Desk | Bureau | Mesa **Fin.** GN, AK  
L 200 P 90 cm | W 78 3/4" D 35 3/8"  
**Dattilo** | Return | Retour | Ala  
L 120 P 60 cm | W 47 1/4" D 23 5/8"

**4. Scrivania** | Desk | Bureau | Mesa **Fin.** NT, CN, EO  
L 200 P 90 cm | W 78 3/4" D 47 1/4"  
**Mobile di servizio** | Service unit | Meuble retour | Mueble de servicio  
L 206 P 60 cm | W 81 1/8" D 25 5/8"









3.



4.

### Piani | Desk tops | Plateaux | Sobres

Spessore 4 cm | 4 cm (1 5/8" thick) | 4 cm d'épaisseur | 4 cm de espesor

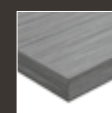

#### Senza profilo - legno/melaminico

Without profile - wood veneer/Italian melamine  
Sans profil - bois/méla minic  
Sin perfil - madera/melaminico

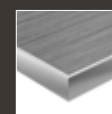

#### Con profilo - legno/melaminico/cuoio/vetro/gres

With profile - wood veneer/Italian melamine/leather/glass/  
porcelain tiles  
Avec profil - bois/méla minic/cuir/verre/grès cérame  
Con perfil - madera/melaminico/cuero/vidrio/gres porcelánico

### Gambe | Legs | Pieds | Patas



#### Gambe pannellata spessore 4 cm

Panel legs 4 cm (1 5/8" thick)  
Piètements panneaux 4 cm d'épaisseur  
Patas paneladas 4 cm de espesor



#### Gambe angolari sezione 9x9 cm

Corner legs section 9x9 cm (3 1/2"x 3 1/2")  
Piètements d'angle section 9x9 cm  
Patas angulares sección 9x9 cm

### Forme dei piani | Desk top shapes | Formes de plateaux | Formas de sobres



### Scrivanie | Desks | Bureaux | Mesas

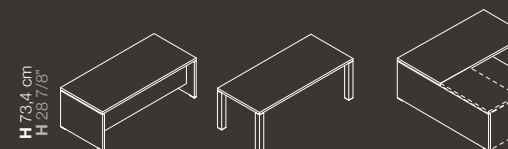

L 180/200 - P 90 cm  
W 70 7/8"-78 3/4" - D 35 3/8"

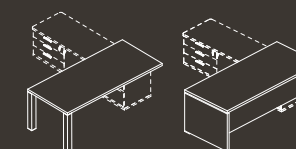

L 180/200 - P 90 cm  
W 70 7/8"-78 3/4" - D 35 3/8"

### Dattilo | Returns | Retours | Alas

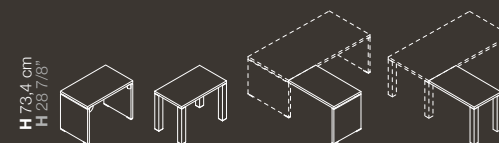

L 100/120 - P 60 cm  
W 39 3/8"-47 1/4" - D 23 5/8"

### Briefing | Briefing | Briefing | Briefing



L 90/180 - P 80/90 cm  
W 35 3/8"-70 7/8" - D 31 1/2"-35 3/8"

### Tavoli riunione | Meeting tables | Tables de réunion | Mesas de juntas



L/P 80/90/100/120/130/150 cm  
W/D 31 1/2"-35 3/8"-39 3/8"-47 1/4"-51 1/8"-59"



L 210/280 - P 120 cm  
W 82 5/8"-110 1/4" - D 47 1/4"

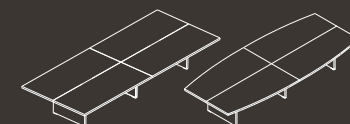

L 420 - P 180 cm  
W 165 3/8" - D 70 7/8"



L 490/560/630 - P 180 cm  
W 192 7/8"-220 1/2"-248" - D 70 7/8"

### Mobili di servizio | Service units | Meuble retour | Muebles de servicio



L 138 - P 62 cm  
W 54 1/2" - D 23 1/2"

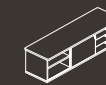

L 180/206 - P 60 cm  
W 70 7/8"-81 1/8" - D 23 5/8"

### Tavolini da caffè | Coffee tables | Tables basses | Mesitas



L/P 60 cm  
W/D 23 5/8"



L 120 - P 60 cm  
W 47 1/4" - D 23 5/8"



# Archimede

**Archimede è una collezione direzionale dal design lineare e leggero. La struttura portante è costituita da gambe in metallo con finitura epossidica o in acciaio inox spazzolato lucido, che presentano tre opzioni di design: ad anello, a T e la distintiva sagoma ad L che permettono di sostenere il piano senza l'ausilio di travi strutturali.**

**I piani sono disponibili in legno (essenza o melaminico) in vetro retrolaccato (anche nella versione antimpronta), cuoio e gres, incorniciati da un profilo in alluminio. Archimede propone inoltre un contenitore laterale strutturale, con piedi abbinati alla scrivania e provvisto di ante scorrevoli, nel quale è possibile includere una cassettera.**

Archimede is an executive collection with a linear and lightweight design. The supporting structure consists of metal legs with an epoxy finish or polished brushed. Legs come in three possible design options: ring shape, T-shaped and L-shaped. All versions allow to support the top without the aid of structural beams.

Tops are available in wood veneer or Italian melamine, in backlacquered glass (also in the antifinger version), leather and porcelain tile, framed by an aluminium profile. Archimede also offers a side unit with sliding doors, with feet matching the desk, a small pedestal can be built into the unit.

Archimede est une collection directionnelle au design linéaire et léger. La structure portante est constituée de pieds en métal en finition époxy ou en acier inoxydable brossé poli, qui ont trois options de conception: l'anneau, la forme en T et la forme en L, qui permettent de supporter le plateau sans utiliser de poutres structurelles.

Les plateaux sont disponibles en bois ou mélaminé, en verre rétro-laqué (également dans la version anti-taches), en cuir et en grès cérame, encadrés par un profil aluminium. Archimede propose également un conteneur latéral structurel, avec des pieds assortis au bureau et équipé de portes coulissantes, dans lequel il est possible d'inclure un bloc tiroir.

Archimede es una colección ejecutiva con un diseño lineal y ligero. La estructura de soporte consiste en patas metálicas con acabado epoxi o en acero inoxidable pulido, que tienen tres opciones de diseño: en forma de anillo, la forma en T y la original forma en L, que permiten soportar el tablero sin el uso de vigas estructurales.

Los tableros están disponibles en madera (madera chapada o melamina) en vidrio lacado por detrás (también en la versión antihuellas), cuero y gres porcelánico, enmarcados por un perfil de aluminio. Archimede también ofrece un contenedor lateral estructural, con pies combinados con el escritorio y equipado con puertas correderas, en el cual es posible incluir una cajonera.

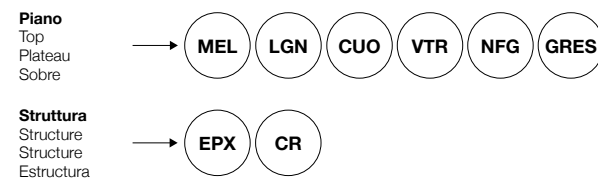

geometric  
sleek  
architectural





# Archimede. collection



**Tavolini**  
Coffee tables  
Tables basses  
Mesitas



**Librerie**  
Bookcases  
Bibliothèques  
Librerías

→ p. 212



**Salè riunioni**  
Meeting rooms  
Salles de réunion  
Salas de reuniones



**Uffici privati**  
Private offices  
Bureaux privés  
Oficinas privadas



**Contenitori**  
Storage  
Rangements  
Contenedores



1.



2.





**1. Scrivania** | Desk | Bureau | Mesa **Fin.** NO, EE, CN  
L 240 P 120 cm | W 94 1/2" D 47 1/4"

**2. Scrivania** | Desk | Bureau | Mesa **Fin.** JN, EN  
L 280 P 120 cm | W 110 1/4" D 47 1/4"

**Mobile di servizio** | Service unit | Meuble retour | Mueble de servicio  
L 160 P 58 cm | W 63" D 22 7/8"

**3. Scrivania** | Desk | Bureau | Mesa **Fin.** MT, ET  
L 240 P 90 cm | W 94 1/2" D 35 3/8"

**Mobile di servizio** | Service unit | Meuble retour | Mueble de servicio  
L 200 P 60 cm | W 78 3/4" D 23 5/8"

**4. Tavolo** | Table | Table | Mesa **Fin.** GN, CR  
L 280 P 120 cm | W 110 1/4" D 47 1/4"

**5. Tavolo** | Table | Table | Mesa **Fin.** NT  
L 280 P 120 cm | W 110 1/4" D 47 1/4"



**Piani** | Desk tops | Plateaux | Sobres

Spessore 4 cm | 4 cm (1 5/8") thick | 4 cm d'épaisseur | 4 cm de espesor

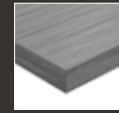

**Senza profilo - legno/melaminico**  
Without profile - wood veneer/Italian melamine  
Sans profil - bois/melaminé  
Sin perfil - madera/melaminico

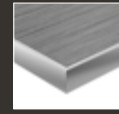

**Con profilo - legno/melaminico/cuoio/vetro/gres**  
With profile - wood veneer/Italian melamine/leather/glass/porcelain tiles  
Avec profil - bois/melaminé/cuir/verre/grès cérame  
Con perfil - madera/melaminico/cuero/vídrío/gres porcelánico

**Gambe** | Legs | Pieds | Patas

Sezione 8x2 cm | Section 8x2 cm (3 1/8"x3/4") thick | Section 8x2 cm | Sección 8x2 cm

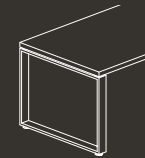

**Gamba ad anello**  
Ring leg  
Pied en anneau  
Pata en anillo

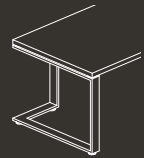

**gamba a L**  
L leg  
pied en L  
pata en L



**Gamba a T**  
T leg  
Pied en T  
Pata en T

**Scrivanie** | Desks | Bureaux | Mesas



H 73.4 cm  
H 28 7/8"  
L 180/200/220/240 - P 90 cm  
W 70 7/8" | 78 3/4" | \*86 5/8" | \*94 1/2" - D 35 3/8"

L 240/280 - P 120 cm  
W 94 1/2"-110 1/4" - D 47 1/4"

**Dattilo** | Returns | Retours | Alas

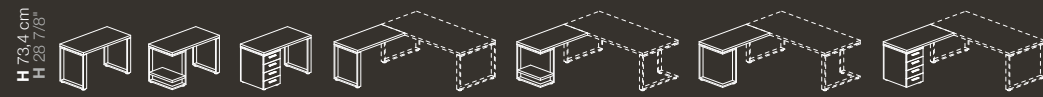

H 73.4 cm  
H 28 7/8"  
L 100/120 - P 60 cm  
W 39 3/8"-47 1/4" - D 23 5/8"

**Tavoli riunione** | Meeting tables | Tables de réunion | Mesas de juntas



H 73.4 cm  
H 28 7/8"  
Ø 100/120/130/150 cm  
Ø 39 3/8"-47 1/4"-51 1/8"-59"

L/P 120/130/150 cm  
W/D 47 1/4"-51 1/8"-59"

L 210/240/280 - P 120 cm  
W 82 5/8" - 94 1/2"-110 1/4" - D 47 1/4"



L 440 - P 150 cm  
W 173 1/4" - D 59"

L 440 - P 120/150 cm  
W 173 1/4" - D 47 1/4"-59"

L 440 - P 120 cm  
W 173 1/4" - D 47 1/4"

L 590 - P 150 cm  
W 232 1/4" - D 59"

L 560 - P 120 cm / L 590 - P 150 cm  
W 220 1/2" - D 47 1/4" / W 232 1/4" - D 59"

L 560 - P 120 cm  
W 220 1/2" - D 47 1/4"

**Mobili di servizio** | Service units | Meuble retour | Muebles de servicio

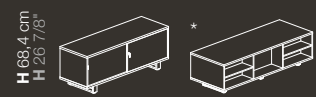

H 88.4 cm  
H 28 7/8"  
L 160/180/200/220 - P 60/90\* cm  
W 63"-70 7/8"-78 3/4"-86 5/8" - D 23 5/8"-35 3/8"\*

\*P 90 cm con vani a giorno esterni  
\*D 90 cm (35 3/8") with external open compartments  
\*D 90 cm avec compartiments extérieurs ouverts  
\*D 90 cm con compartimentos abiertos externos

**Tavolini da caffè** | Coffee tables | Tables basses | Mesitas

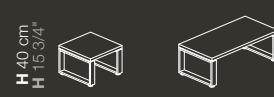

H 40 cm  
H 15 3/4"  
L/P 60 cm  
W/D 23 5/8"

L 120 - P 60 cm  
W 47 1/4" - D 23 5/8"

**Librerie** | Bookshelves | Bibliothèque | Librerías

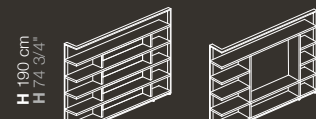

H 190 cm  
H 74 3/4"  
L 272 - P 36 cm  
W 107 1/8" - D 14 1/8"

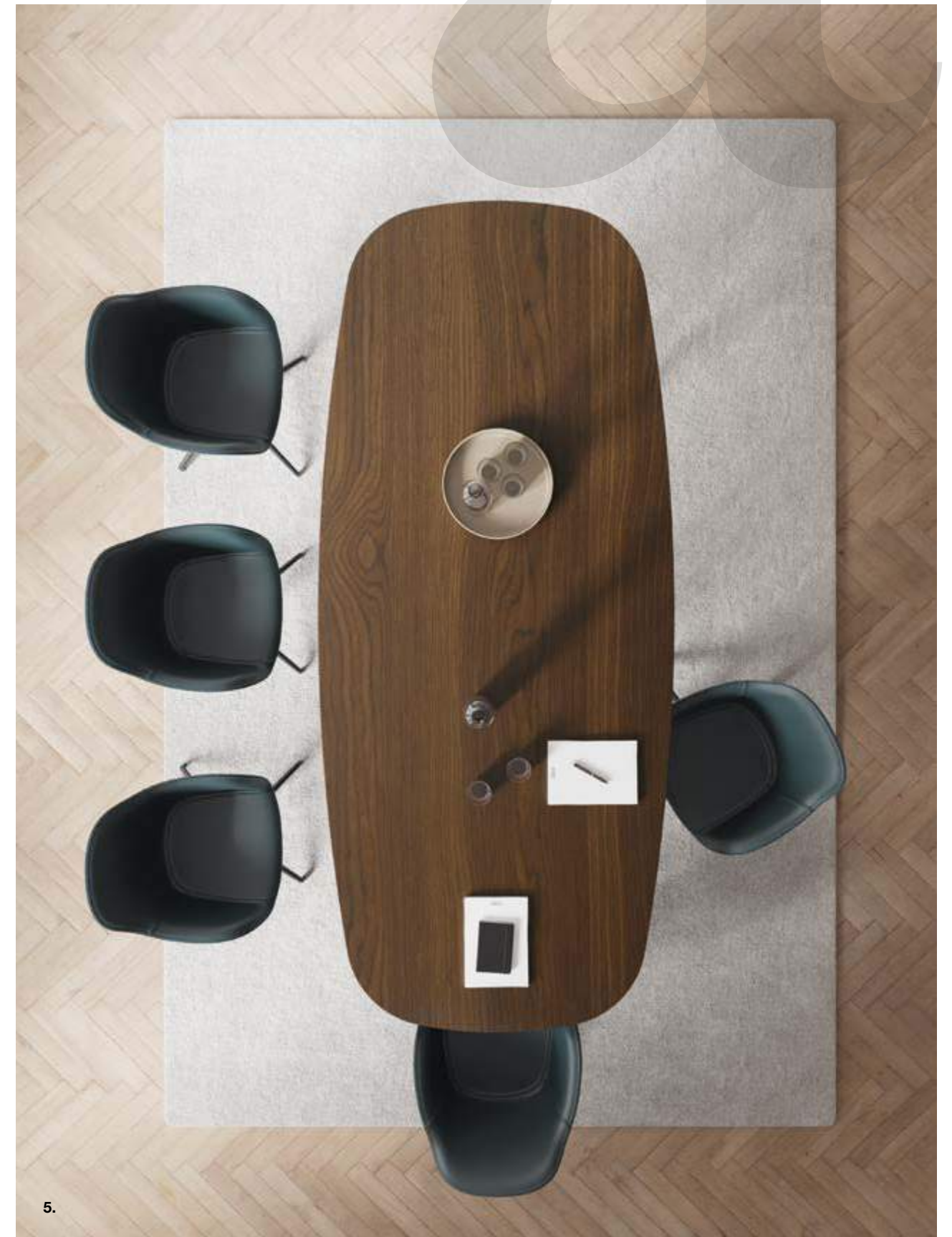

5.



# Blade X

**Blade X è una collezione direzionale moderna caratterizzata da un design raffinato ed originale.**

**Il piano scrivania può avere bordature sia dritte che smussate, mentre la gamba in acciaio tagliata a laser può arricchirsi di rivestimenti in legno massello con essenza abbinata al piano scrivania oppure in cuoio e ad un eventuale contenitore laterale strutturale.**

**La versione più prestigiosa della scrivania propone un piano trapezoidale di larghe dimensioni, con contenitore laterale e cassetto portapenne in massello.**

Blade X is a modern managerial collection characterized by a refined and original design.

The desktop can have straight or chamfered edges, while the laser-cut steel leg can be enriched with leather or solid wood veneer covers matching the desktop and storage material and finish.

The most prestigious version of the desk, offers a large size trapezoidal top, with lateral storage unit and a solid wood pen tray.

Blade X est une collection directionnelle moderne reconnaissable grâce à son design raffiné et original.

Le plateau du bureau est disponible avec chant droit ou biseauté. Le pied en acier coupé au laser peut être enrichi d'un habillage en cuir ou en bois massif sur ses deux faces. Il peut être assorti à la finition du plateau ainsi que son meuble de service.

La version la plus prestigieuse du bureau dispose d'un grand plateau trapézoïdal, avec un conteneur latéral et un tiroir-plumier en bois massif.

Blade X es una colección direccional moderna, caracterizada por un diseño lineal y cautivador.

La pata de acero cortada con láser puede enriquecerse con cubiertas de cuero o de madera maciza con chapa que coincida con la parte superior del escritorio y la unidad de almacenamiento estructural.

La versión más prestigiosa del escritorio ofrece una tapa trapezoidal de gran tamaño con una unidad de almacenamiento lateral y un cajón portalápices en madera maciza.

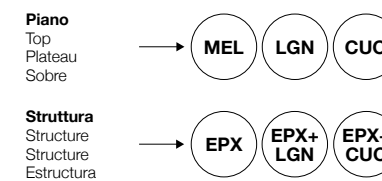

sophisticated  
charismatic  
contemporary

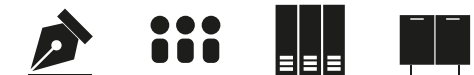



# Blade X. collection



**Uffici privati**  
Private offices  
Bureaux privés  
Oficinas privadas

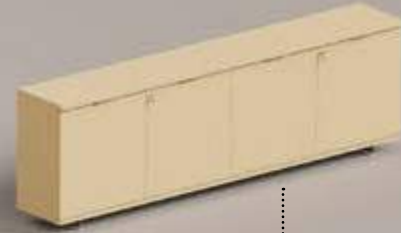

**Credenze**  
Sideboards  
Buffets  
Aparador  
→ p. 242



**Sale riunioni**  
Meeting rooms  
Salles de réunion  
Salas de reuniones



**Contenitori**  
Storage  
Rangements  
Contenedores

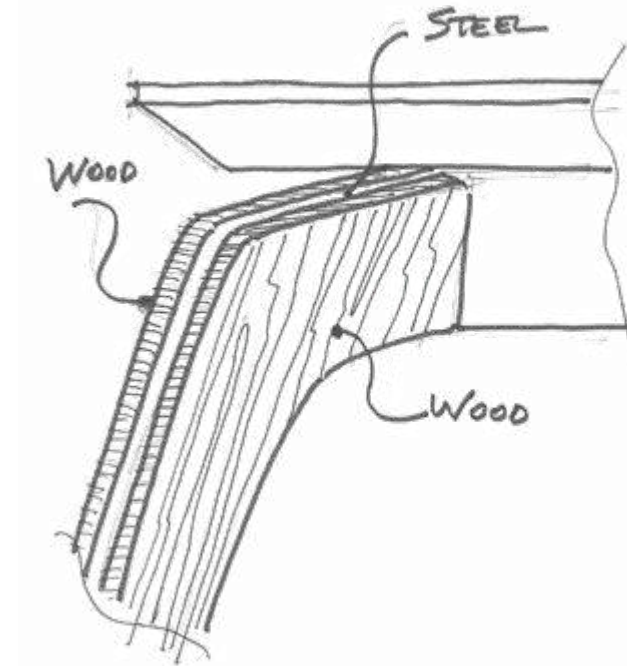





3.



5.



4.

- 1. Tavolo** | Table | Table | Mesa **Fin.** RG, EB  
L 280 P 120 cm | W 110 1/4" D 47 1/4"
- 2. Tavolo** | Table | Table | Mesa **Fin.** AK, EE  
L 420 P 120 cm | W 165 3/8" D 47 1/4"
- 3. Scrivania** | Desk | Bureau | Mesa **Fin.** NO, EI  
L 220 P 90 cm | W 86 5/8" D 35 3/8"
- 4. Scrivania** | Desk | Bureau | Mesa **Fin.** NT, EU, CM  
L 240 P 120 cm | W 94 1/2" D 47 1/4"  
**Mobile di servizio** | Service unit | Meuble retour | Mueble de servicio  
L 208 P 62 cm | W 94 1/2" D 24 3/8"
- 5. Scrivania** | Desk | Bureau | Mesa **Fin.** AK, EO  
L 200 P 90 cm | W 78 3/4" D 35 3/8"  
**Mobile di servizio** | Service unit | Meuble retour | Mueble de servicio  
L 145 P 62 cm | W 57 1/8" D 24 3/8"
- 6. Scrivania** | Desk | Bureau | Mesa **Fin.** ME, EZ  
L 220 P 90 cm | W 86 5/8" D 35 3/8"  
**Dattilo** | Return | Retour | Ala  
L 100 P 60 cm | W 39 3/8" D 23 5/8"
- 7. Tavolo** | Table | Table | Mesa **Fin.** CE, EZ  
L 120 P 120 cm | W 47 1/4" D 47 1/4"





6.

**Piani | Desk tops | Plateaux | Sobres**

**Spessore 3 cm | 3 cm (1 1/8" thick | 3 cm d'épaisseur | 3 cm de espesor**

**Melaminico**  
Italian melamine  
Mélaminé  
Melaminico

**Legno**  
Wood veneer  
Bois  
Madera

**Legno con bordi smussati**  
Wood veneer with chamfered edge  
Bois avec bords biseautés  
Madera con bordes biselados

**Legno e cuoio con bordi smussati**  
Wood veneer and leather with chamfered edge  
Bois et cuir avec bords biseautés  
Madera y cuero con bordes biselados

**Gambe | Legs | Pieds | Patas**

**Spessore 1,2 cm | 1,2 cm (1/2" thick | 1,2 cm d'épaisseur | 1,2 cm de espesor**

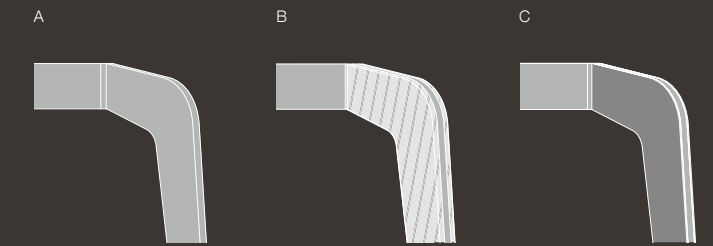

**A) Metallo verniciato epossidico B) Con rivestimento in legno C) Con rivestimento in cuoio**  
A) Metal epoxy painted B) With wood veneer cover C) With leather cover  
A) Métal peint epoxy B) Avec revêtement en bois C) Avec revêtement en cuir  
A) Metal pintado epoxy B) Con recubrimiento de madera C) Con recubrimiento de cuero

**Scrivanie | Desks | Bureaux | Mesas**

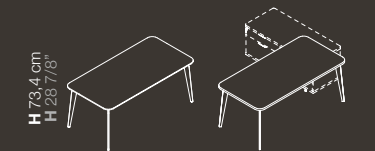

**L 180/200/220/240 - P 90 cm**  
**W 70 7/8"-78 3/4"-86 5/8"-94 1/2" - D 35 3/8"**

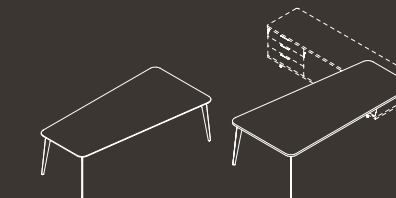

**L 240 - P 120 cm**  
**W 94 1/2" - D 47 1/4"**

**Dattilo | Returns | Retours | Alas**

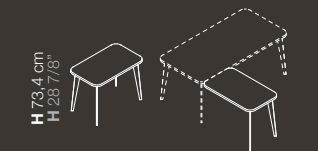

**L 80/100/120 - P 60 cm**  
**L 31 1/2"-39 3/8"-47 1/4" - P 23 5/8"**

**Tavoli riunione | Meeting tables | Tables de réunion | Mesas de juntas**

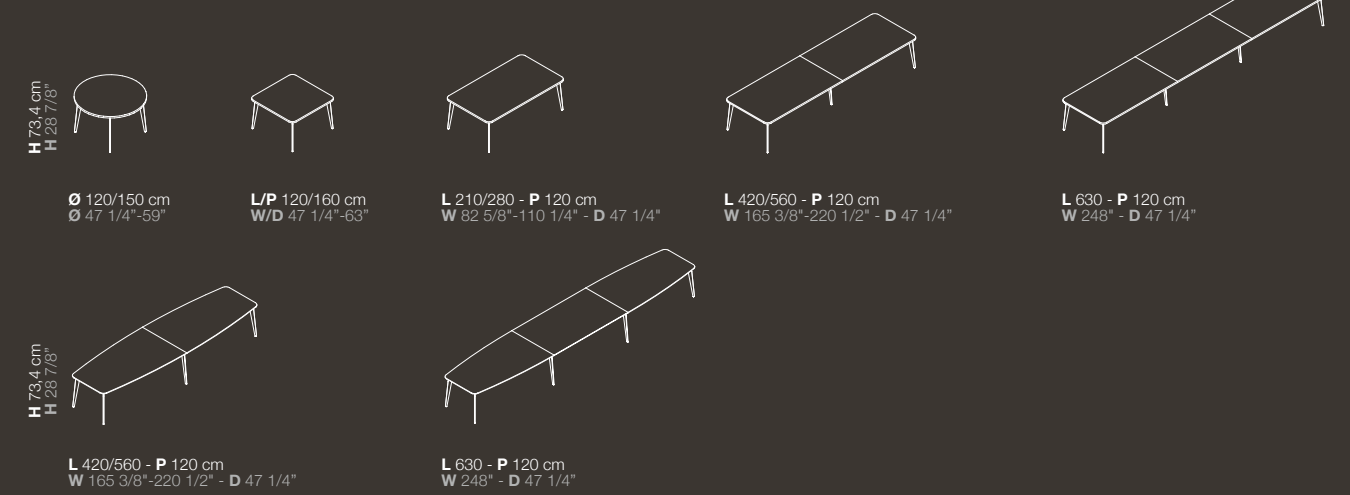

**Mobili di servizio | Service units | Meuble retour | Muebles de servicio**

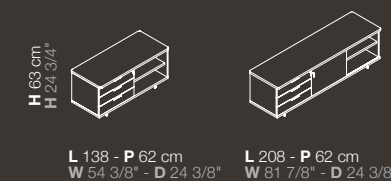

**Credenze | Credenzas | Buffets | Muebles**

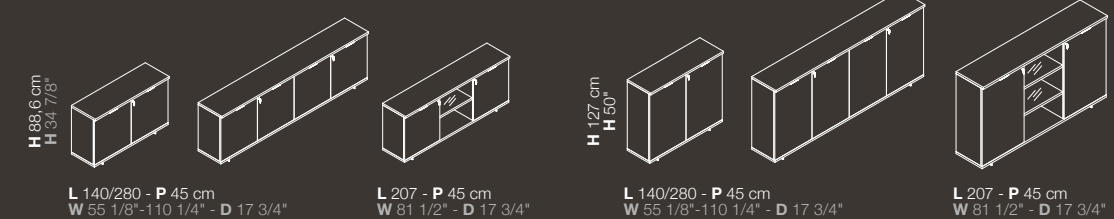

7.



# Zefiro X

**Zefiro è una delle collezioni più amate di sempre. Nel 2003, anno della sua nascita, è stato inserito nel volume ADI Design Index, che lo ha celebrato come uno dei prodotti più significativi di quel periodo.**

**Oggi riproponiamo quel design, con una rivisitazione in chiave moderna, introducendo nuovi materiali e finiture per una veste puramente direzionale. Nasce così Zefiro X, che si declina in scrivanie, scrittoi e tavoli riunione.**

**Il design di Zefiro X rimane in equilibrio tra la forma e la funzione. La sua struttura si presenta sia con gamba di sezione quadrata, forte e lineare, che di sezione ad L, dove la tecnicità si fa più presente.**

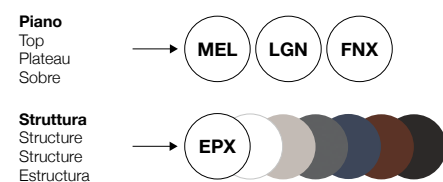

Zefiro is one of the most popular collections ever. In 2003, the year of its birth, it was included in the ADI Design Index volume, which celebrated it as one of the most significant products of that period.

Today we are re-proposing that design, with a modern twist, introducing new materials and finishes for a purely managerial look. This is how Zefiro X was born, in the form of desks, writing desks and meeting tables.

Zefiro X design maintains a balance between form and function. Its structure comes either with a strong and linear square section leg, or with an L section, where technicality becomes more present.

Zefiro est l'une des collections les plus populaires de tous les temps. En 2003, l'année de sa naissance, il a été inclus dans le volume de ADI Design Index, qui l'a célébré comme l'un des produits les plus significatifs de cette période.

Aujourd'hui, nous repropsons ce design, avec une touche de modernité, en introduisant de nouveaux matériaux et de nouvelles finitions pour un look purement managérial. C'est ainsi qu'il est né Zefiro X, sous la forme de bureaux, de pupitres et de tables de réunion.

Le design du Zefiro X reste en équilibre entre forme et fonction. Sa structure se présente soit avec un pied à section carrée forte et linéaire, soit avec une section en L, où la technicité est plus présente.

Zefiro es una de las colecciones más populares de la historia. En 2003, el año de su nacimiento, se incluyó en el volumen ADI Design Index, que lo celebraba como uno de los productos más significativos de la época.

Hoy volvemos a proponer ese diseño, con un toque moderno, introduciendo nuevos materiales y acabados para un aspecto puramente empresarial. Así nació Zefiro X, en forma de mesas de trabajo, escritorios y mesas de reunión.

El diseño de Zefiro X mantiene el equilibrio entre forma y función. Su estructura se presenta con una pata de sección cuadrada, fuerte y lineal, o con una sección en L, donde la tecnicidad está más presente.

linear  
design  
smart





# Zefiro X. collection



**Uffici privati**  
Private offices  
Bureaux privés  
Oficinas privadas



**Salas riunioni**  
Meeting rooms  
Salles de réunion  
Salas de reuniones



**Piani** | Desk tops | Plateaux | Sobres

Spessore 1,2 cm | 1,2 cm (1/2") thick | 1,2 cm d'épaisseur | 1,2 cm de espesor

**Melaminico/Legno/Fenix**  
Melamine/Wood veneer/Fenix  
Mélaminé/Bois/Fenix  
Melaminico/Madera/Fenix



**Gambe** | Legs | Pieds | Patas

Sezione 5,4x5,4 cm | Section 5,4x5,4 cm (2 1/8"x2 1/8") thick | Section 5,4x5,4 cm | Sección 5,4x5,4 cm

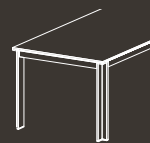

**Sezione a L in alluminio**  
L section, aluminium  
Section L, en aluminium  
Sección en L, en aluminio

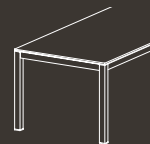

**Sezione quadrata in alluminio**  
Square section, aluminium  
Section carrée, en aluminium  
Sección cuadrada, en aluminio

**Scrivanie** | Desks | Bureaux | Mesas

H 73,4 cm  
H 28 7/8"

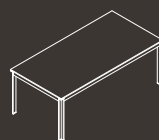

L 180/200 - P 90 cm  
W 70 7/8"-78 3/4" - D 35 3/8"

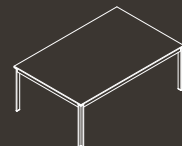

L 200/240/280 - P 120 cm  
W 78 3/4"-94 1/2"-110 1/4" - D 47 1/4"

**Dattilo** | Returns | Retours | Alas

H 73,4 cm  
H 28 7/8"



L 120/140/160/180 - P 60 cm  
W 47 1/4"-55 1/8"-63"-70 7/8" - D 23 5/8"

**Tavoli riunione** | Meeting tables | Tables de réunion | Mesas de juntas

H 73,4 cm  
H 28 7/8"



L/P 90/120 cm  
W/D 35 3/8"-47 1/4"

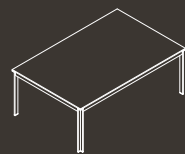

L 200/240/280 - P 120 cm  
W 78 3/4"-94 1/2"-110 1/4" - D 47 1/4"

H 73,4 cm  
H 28 7/8"



L/P 150 cm  
W/D 59"

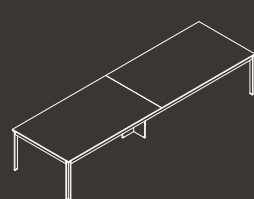
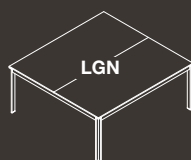

L 400 - P 120 cm  
W 157 1/2" - D 47 1/4"

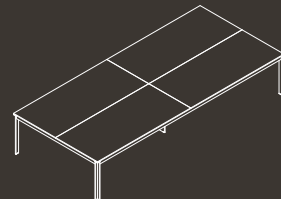

L 400 - P 180 cm  
W 157 1/2" - D 70 7/8"

**Basamenti per tavoli multipli L 400 cm** | Support for multiple tables W 400 cm (157 1/2") | Bases pour tables multiples L 400 cm | Bases para mesas múltiples L 400 cm



**Basamento ispezionabile in metallo verniciato epossidico**  
Inspectable epoxy painted metal basement  
Base inspectable métallique peinte à l'époxy  
Base inspeccionable metálica pintada con epoxi



**Basamento a croce in metacrilato trasparente**  
Cross transparent acrylic base  
Piètement en forme de croix en méthacrylate transparent  
Base en forma de cruz en metacrilato transparente



3.



4.



5.

**1. Scrivanía** | Desk | Bureau | Mesa **Fin.** XE, EB  
L 280 P 120 cm | W 110 1/4" D 47 1/4"

**2. Tavolo** | Table | Table | Mesa **Fin.** XC, YC  
L 400 P 120 cm | W 157 1/2" D 47 1/4"

**3. Tavolo** | Table | Table | Mesa **Fin.** NT, EN  
L/P 150 cm | W/D 59"

**4. Scrivanía** | Desk | Bureau | Mesa **Fin.** XB, YB  
L 280 P 120 cm | W 110 1/4" D 47 1/4"

**5. Tavolo** | Table | Table | Mesa **Fin.** XA, EN  
L 400 P 120 cm | W 157 1/2" D 47 1/4"



# Oasi

**Il design di Oasi è raffinato e contemporaneo e combina comfort e funzionalità.**

**La sua peculiarità consiste nella coppia di lame in metallo che sostengono il piano scrivania, il quale è caratterizzato dalla possibilità di abbinare due materiali insieme ad un profilo perimetrale in alluminio.**

**Tutto è a portata di mano e le soluzioni per contenimento ed elettrificazione sono discrete ed eleganti.**

Oasi's design is sophisticated and modern, providing comfort and functionality at the same time.

Oasi's distinctiveness is a pair of metal blades that support the desk top. The latter features the possibility of combining two materials with an aluminium frame.

Everything is at your fingertips and the solutions for storage and wire management are discreet and elegant.

Le design de Oasi est raffiné et contemporain, il allie confort et fonctionnalité.

La particularité de Oasi consiste en une paire de lames métalliques qui supporte le bureau. Ce dernier se caractérise par la possibilité de combiner deux matériaux avec le chant périmétrique en aluminium.

Tout est à portée de main et les solutions de rangement et d'électrification sont discrètes et élégantes.

El diseño de Oasi es refinado y contemporáneo y combina confort y funcionalidad.

La peculiaridad de Oasi consiste en el par de hojas de metal que soportan el sobre de la mesa. Este último se caracteriza por la posibilidad de combinar dos materiales junto con un perfil perimetral de aluminio.

Todo está a la mano y las soluciones para contención y la electrificación son discretas y elegantes.

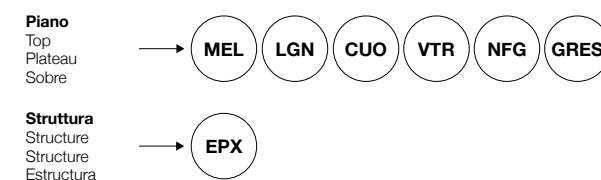

contrast  
crisp  
high-end





# Oasi. collection



**Sale riunioni**  
Meeting rooms  
Salles de réunion  
Salas de reuniones



**Credenze**  
Sideboards  
Buffets  
Aparador

p. 246 ←



**Contentori**  
Storage  
Rangements  
Contenedores



**Uffici privati**  
Private offices  
Bureaux privés  
Oficinas privadas

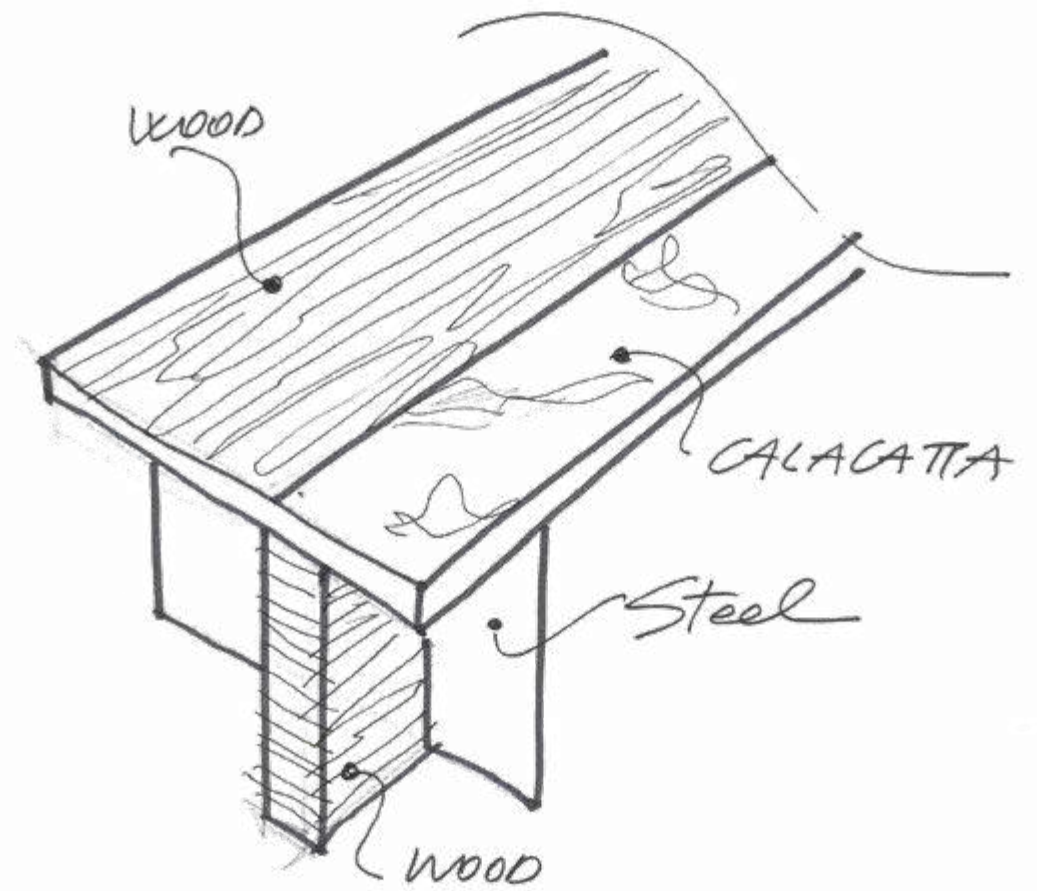





**1. Scrivania** | Desk | Bureau | Mesa **Fin.** AK, JC, EI  
**L** 200 **P** 100 cm | **W** 78 3/4" **D** 39 3/8"

**2. Tavolo** | Table | Table | Mesa **Fin.** AK, CN, EN  
**L** 630 **P** 180 cm | **W** 248" **D** 70 7/8"

**3. Tavolo** | Table | Table | Mesa **Fin.** RC, ES  
**L** 280 **P** 120 cm | **W** 110 1/4" **D** 47 1/4"

**4. Scrivania** | Desk | Bureau | Mesa **Fin.** AK, CN, EZ  
**L** 240 **P** 120 cm | **W** 94 1/2" **D** 47 1/4"

**Mobile di servizio** | Service unit | Meuble retour | Mueble de servicio  
**L** 207 **P** 60 cm | **W** 81 1/2" **D** 23 5/8"

**5. Scrivania** | Desk | Bureau | Mesa **Fin.** NO, CN, EZ  
**L** 240 **P** 120 cm | **W** 94 1/2" **D** 47 1/4"

**Mobile di servizio** | Service unit | Meuble retour | Mueble de servicio  
**L** 207 **P** 60 cm | **W** 81 1/2" **D** 23 5/8"



2.

3.



**Piani** | Desk tops | Plateaux | Sobres

Spessore 4 cm | 4 cm (1 5/8") thick | 4 cm d'épaisseur | 4 cm de espesor



**Senza profilo - legno/melaminico**  
Without profile - wood veneer/Italian melamine  
Sans profil - bois/melaminé  
Sin perfil - madera/melaminico

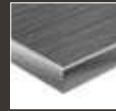

**Con profilo - legno/melaminico/cuoio/vetro/gres**  
With profile - wood veneer/Italian melamine/leather/glass/porcelain tiles  
Avec profil - bois/melaminé/cuir/verre/grès cérame  
Con perfil - madera/melaminico/cuero/vidrio/gres porcelánico

**Struttura** | Structure | Structure | Estructura

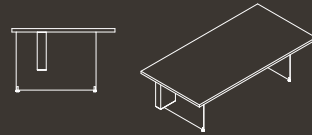

**Modesty rialzato di 250 mm**  
250 mm raised modesty panel  
Voile de fond relevé de 250 mm  
Faldón elevado de 250 mm

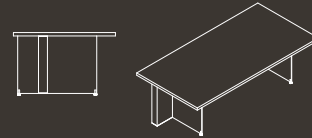

**Modesty a tutta altezza**  
Full-height modesty panel  
Voile de fond toute hauteur  
Faldón altura total

**Scrivanie** | desks | bureaux | mesas

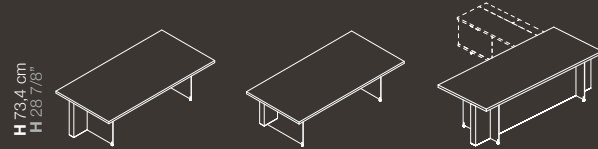

H 73,4 cm  
H 28 7/8"

L 200/220/240 - P 100/120 cm  
W 78 3/4"-86 5/8"-94 1/2" - D 39 3/8"-47 1/4"

**Dattilo/briefing** | return/briefing | retour/briefing | ala/briefing

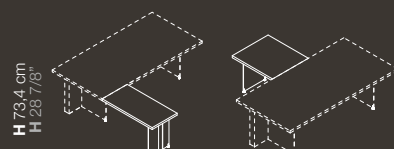

H 73,4 cm  
H 28 7/8"

L 120 - P 60 cm W 47 1/4" - D 23 5/8"  
L 90/180 - P 80/90 cm W 35 3/8"-70 7/8" - D 31 1/2"-35 3/8"

**Tavoli riunione** | meeting tables | tables de réunion | mesas de juntas

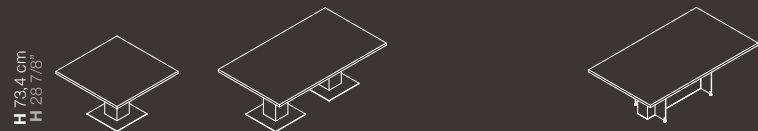

H 73,4 cm  
H 28 7/8"

L/P 120 cm W/D 47 1/4"  
L 210/280 P 120 cm W 82 5/8"-110 1/4"- D 47 1/4"  
L 210/280 - P 120 cm W 82 5/8"-110 1/4" W 47 1/4"

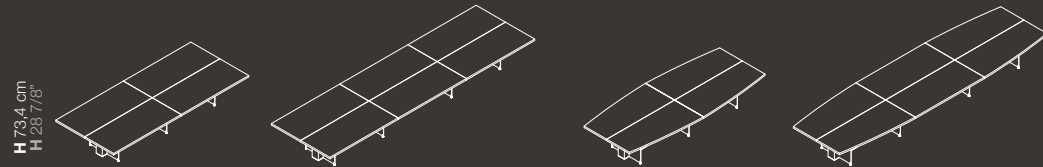

H 73,4 cm  
H 28 7/8"

L 420 - P 180 cm W 165 3/8" - D 70 7/8"  
L 490/560/630 - P 180 cm W 192 7/8"-220 1/2"-248" - D 70 7/8"  
L 420 - P 180 cm W 165 3/8" - D 70 7/8"  
L 490/560/630 - P 180 cm W 192 7/8"-220 1/2"-248" - D 70 7/8"

**Mobili di servizio** | service units | meuble retour | muebles de servicio



H 57 cm  
H 22 1/2"

L 138 - P 60 cm W 54 3/8" - D 23 5/8"  
L 207 - P 60 cm W 81 1/2" - D 23 5/8"

**Credenze** | credenzas | buffets | muebles



H 86 cm  
H 33 7/8"

L 242 - P 45,5 cm W 95 1/4" - D 17 7/8"  
L 254 - P 47,5 cm W 100" - D 18 3/4"



4.



5.



# Crono X

**Crono è un sistema di scrivanie regolabili elettricamente in altezza.**

**Il sistema è stato studiato e progettato per rispondere alla necessità di creare postazioni di lavoro ergonomiche, capaci di maggiore attenzione alla salute e al benessere dell'utilizzatore.**

**La collezione Crono prevede delle composizioni che soddisfano le esigenze direzionali proponendo gambe integrate a muretti, che possono abbinarsi anche a contenitori laterali strutturali.**

Crono is an electrical height-adjustable system fitting freestanding desks.

The system has been designed to respond to the demand of ergonomic workstations oriented to the health and well-being of the user.

Crono collection includes compositions that meet executive needs by offering legs solid legs, which can also be combined with structural side storage.

Crono est un système de bureaux réglables en hauteur avec commande électronique.

Le système a été étudié et conçu pour répondre à la nécessité de créer des postes de travail ergonomiques et de prêter plus d'attention à la santé et au bien-être de l'utilisateur.

La collection Crono prévoit des compositions qui satisfont également les exigences directionnelles en proposant pieds intégrés aux "parois". Cette "paroi" a la possibilité de s'assortir à la finition du meuble retour structurel.

Crono es un sistema de mesas y estaciones de trabajo regulables eléctricamente en altura.

El sistema ha sido estudiado y diseñado para responder a la necesidad de crear puestos de trabajo ergonómicos orientados a la salud y el bienestar del usuario.

La colección Crono también puede utilizarse para despachos de dirección gracias a las patas "costados", que también pueden combinarse con armarios laterales estructurales.

Piano  
Top  
Plateau  
Sobre



Struttura  
Structure  
Structure  
Estructura



functional  
ergonomic  
strong





# Crono X. collection



**Contenitori**  
Storage  
Rangements  
Contenedores



**Uffici privati**  
Private offices  
Bureaux privés  
Oficinas privadas

**1. Scrivania** | Desk | Bureau | Mesa **Fin. NT, EI**  
L 200 P 90 cm | W 78 3/4" D 35 3/8"  
**Mobile di servizio** | Service unit | Meuble retour | Mueble de servicio  
L 200 P 580 cm | W 78 3/4" D 22 7/8"

**2. Scrivania** | Desk | Bureau | Mesa **Fin. RG, EI**  
L 200 P 90 cm | W 78 3/4" D 35 3/8"

**3. Scrivania** | Desk | Bureau | Mesa **Fin. NT, EI**  
L 200 P 90 cm | W 78 3/4" D 35 3/8"  
**Mobile di servizio** | Service unit | Meuble retour | Mueble de servicio  
L 200 P 580 cm | W 78 3/4" D 22 7/8"









Piani e strutture | Desk tops and structures | Plateaux et structures | Sobres y estructuras

**Spessore 3 cm - melaminico/legno**  
 3 cm (1 1/8") thick - Italian melamine/wood veneer  
 3 cm d'épaisseur - mélaminé/bois  
 3 cm de espesor - melaminico/madera

1 step  
 1 step  
 1 niveau  
 1 step

Pulsantiera | Handswitch | Tableau | Mando de control

**A) Pulsantiera semplice, B) pulsantiera con 4 memorie**  
 A) Basic handswitch, B) handswitch with 4 memories  
 A) Tableau simple, B) tableau avec 4 mémoires  
 A) Mando de control simple, B) mando de control con 4 memorias

Piede scrivania freestanding | Freestanding desk foot | Pied pour bureau individuel | Pie para mesa individual

**A) Dritto simmetrico, B) Muretto**  
 A) Straight symmetrical, B) Solid leg  
 A) Droit symétrique, B) Cloison  
 A) Recto simétrico, B) Costado

H 73.4 cm  
 H 28 7/8"

Scrivanie | Desks | Bureaux | Mesas

**L 180/200 - P 80/90 cm**  
 W 70 7/8"-78 3/4" - D 31 1/2"-35 3/8"

**L 180/200 - P 80/90 cm**  
 W 70 7/8"-78 3/4" - D 31 1/2"-35 3/8"

Mobili di servizio | Service units | Meuble retour | Muebles de servicio

**H 60 cm**  
 H 23 5/8"

**L 141,6/180/190 - P 58 cm**  
 W 55 3/4"-70 7/8"-74 3/4" - D 22 7/8"







# Titano

**Titano è una collezione direzionale di alta gamma che si contraddistingue per un design dai segni forti e rigorosi, accentuati anche dallo spessore di 60 mm di piani e gambe. L'eleganza del disegno si tramuta nell'attenta cura del dettaglio, nell'uso di materiali di grande qualità (legno e cuoio) e nella sapiente maestria artigianale.**

**La collezione Titano si articola in varie tipologie di tavoli, tra le quali spiccano le scrivanie freestanding con gambe a sezione rettangolare che si possono assemblare a "schema libero" in quanto, al momento dell'aggregazione al piano, è possibile decidere la loro posizione, secondo molteplici possibilità compositive che creano originali geometrie.**

**Titano offre inoltre la possibilità di aggregare alla scrivania, un contenitore laterale strutturale dotato di anta scorrevole e cassettera integrata.**

Titano is a high-end collection that stands out for its strong and rigorous design features, emphasized also by its 60 mm (2 3/8") thick tops and legs. The elegance of the design is a result of attention to details, use of high quality materials (wood and leather) and excellent craftsmanship.

The Titano collection is divided into various styles of tables, among which stands out the freestanding desk with rectangular section legs; the latter can have multiple positions and orientations and their location below the desk can be chosen on site.

Titano also offers a structural side unit with sliding doors with a built in pedestal option.

Very wide is also the choice among modular meeting tables.

Titano est une collection directionnelle haut de gamme qui se distingue par son design fort et rigoureux, accentué par les plateaux et les pieds de 60 mm d'épaisseur. L'élégance du design se traduit par une attention particulière aux détails, par l'utilisation de matériaux de haute qualité (bois et cuir) et par l'habileté de l'exécution.

La collection Titano est divisée en différents types de tables, parmi lesquelles se détachent les bureaux autoportants à pieds rectangulaires qui peuvent être assemblés selon un "schéma libre" car, au moment du montage, il est possible de changer la configuration en utilisant les perçages prévus sur le plateau.

Titano offre également la possibilité d'ajouter un caisson latéral structurel avec porte coulissante et caissons intégrés.

Titano es una colección de alta gama que se caracteriza por un diseño con signos fuertes y rigurosos, acentuados también por el grosor de 60 mm de tableros y patas. La elegancia del diseño se convierte en una cuidadosa atención al detalle, en el uso de materiales de alta calidad (madera y cuero) y una artesanía experta.

La colección Titano se articula en varios modelos de mesas, entre las cuales resaltan escritorios independientes con patas de sección rectangular. En el momento de la agregación con el tablero, es posible decidir la posición de las patas según múltiples posibilidades compositivas que crean geometrías originales.

Titano también ofrece la posibilidad de agregar al escritorio, un contenedor lateral estructural con puerta corredera y cajonera integrada.

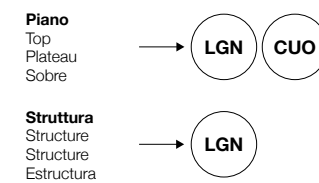

thick  
modern  
robust







**Librerie**  
Bookcases  
Bibliothèques  
Libreros  
→ p. 208



**Uffici privati**  
Private offices  
Bureaux privés  
Oficinas privadas



**Tavolini**  
Coffee tables  
Tables basses  
Mesitas



**Sale riunioni**  
Meeting rooms  
Salles de réunion  
Salas de reuniones



**Contenitori**  
Storage  
Rangements  
Contenedores

# Titano. collection







2.



3.





**1. Tavolo** | Table | Table | Mesa **Fin. AK**  
**L 630 P 180 cm | W 248" D 70 7/8"**

**2. Scrivania** | Desk | Bureau | Mesa **Fin. AK, MT**  
**L 220 P 100 cm | W 86 5/8" D 39 3/8"**  
**Mobile di servizio** | Service unit | Meuble retour | Mueble de servicio  
**L 178 P 63 cm | W 70 1/8" D 24 3/4"**

**3. Tavolino da caffè** | Coffee table | Table basse | Mesita **Fin. AK**  
**L/P 60 cm | W/D 23 5/8"**

**4. Scrivania** | Desk | Bureau | Mesa **Fin. GN, AK**  
**L 200 P 100 cm | W 78 3/4" D 39 3/8"**

**Piano** | Desk top | Plateau | Sobre  
**Spessore 6 cm** | 6 cm (2 3/8") thick | 6 cm d'épaisseur | 6 cm de espesor

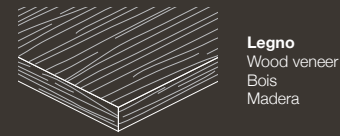

**Legno**  
 Wood veneer  
 Bois  
 Madera

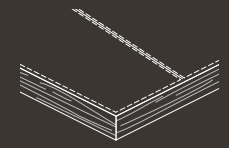

**Legno con applicazione cuoio, cuciture a vista**  
 Wood veneer with leather application, visible stitching  
 Bois avec application de cuir, coutures visibles  
 Madera con aplicación de cuero, costuras a la vista

**Gambe** | Legs | Pieds | Patas  
**Spessore 7,7 cm** | 7,7 cm (3") thick | 7,7 cm d'épaisseur | 7,7 cm de espesor

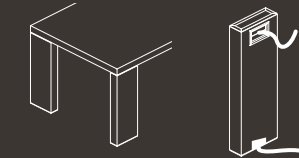

**Gambe angolari**  
 Corner legs  
 Piètements d'angle  
 Patas angulares

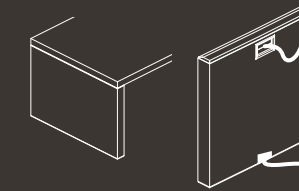

**Gambe pannellate**  
 Panel legs  
 Piètements panneaux  
 Patas paneladas

**Scrivanie** | Desks | Bureaux | Mesas

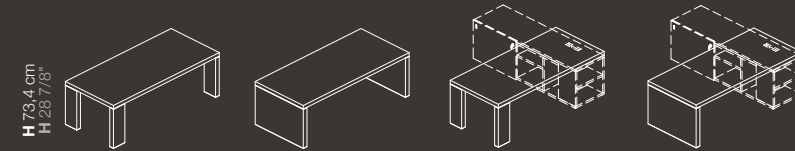

**H 73,4 cm**  
**H 28 7/8"**

**L 200/220 - P 100 cm**  
**W 78 3/4"-86 5/8" D 39 3/8"**

**Dattilo** | Returns | Retours | Alas

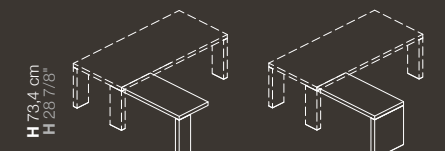

**H 73,4 cm**  
**H 28 7/8"**

**L 100/110/120 - P 60 cm**  
**W 39 3/8"-43 1/4"-47 1/4" D 23 5/8"**

**Tavoli riunione** | Meeting tables | Tables de réunion | Mesas de juntas

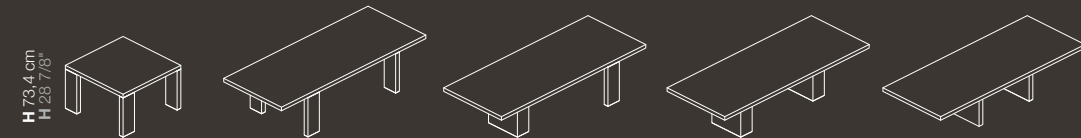

**H 73,4 cm**  
**H 28 7/8"**

**L/P 120 cm**  
**W/D 47 1/4"**

**L 240/300 - P 120 cm**  
**W 94 1/2"-118 1/8" - D 47 1/4"**

**H 73,4 cm**  
**H 28 7/8"**

**L 420 - P 180 cm**  
**W 165 3/8" - D 70 7/8"**

**L 630 - P 180 cm**  
**W 248" - D 70 7/8"**

**L 840 - P 180 cm**  
**W 330 3/4" - D 70 7/8"**

**H 73,4 cm**  
**H 28 7/8"**

**L/P 80/90/100/120 cm**  
**W/D 31 1/2"-35 3/8"-39 3/8"-47 1/4"**

**L 240/300 - P 120 cm**  
**W 94 1/2"-118 1/8" - D 47 1/4"**

**Tavolini da caffè** | Coffee tables | Tables basses | Mesitas

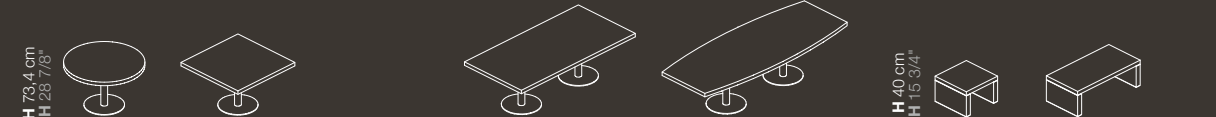

**H 40 cm**  
**H 15 3/4"**

**L/P 60 cm**  
**W/D 23 5/8"**

**L 120 - P 60 cm**  
**W 47 1/4" - D 23 5/8"**

**Mobili di servizio** | Service units | Meuble retour | Muebles de servicio



**H 66,5 cm**  
**H 26 1/8"**

**L 178 - P 63 cm**  
**W 70 1/8" - D 24 3/4"**

**L 210 - P 63 cm**  
**W 82 5/8" - D 24 3/4"**

**Console** | Console | Console | Console



**H 82,5 cm**  
**H 32 1/2"**

**L 180 - P 60 cm**  
**W 70 7/8" - D 23 5/8"**

**Moduli** | Modules | Modules | Módulos



**H 68 cm**  
**H 15"**

**L 38/79 - P 39,4 cm**  
**W 15"-31 1/8" - D 15 1/2"**

**Dimensioni vano utile**  
 Internal dimensions  
 Dimensions utiles du module  
 Dimensiones útiles del módulo

**Esempi librerie** | Example bookshelves | Exemples bibliothèque | Ejemplos libreros

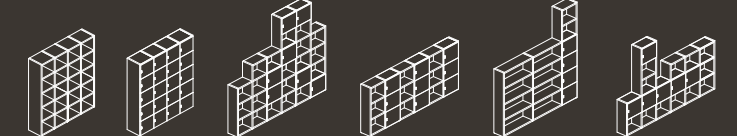



# Eracle

**Resistenza, armonia ed equilibrio sono le qualità che vengono riconosciute alle cose destinate a durare nel tempo.**

**Per questo motivo il design di Eracle è diventato un classico.**

**I suoi tavoli e scrivanie si distinguono infatti per le forme ricercate e lo studio di materiali innovativi.**

**Le gambe in alluminio sono il segno di riconoscimento di questa collezione, grazie alla loro particolare sfaccettatura a "diamante" che innalza il livello di ricercatezza.**

**Per i piani, si può invece scegliere tra numerosi materiali, dal melaminico al legno, dal cuoio al vetro, e ancora il gres porcellanato, sempre incorniciati da un telaio in alluminio.**

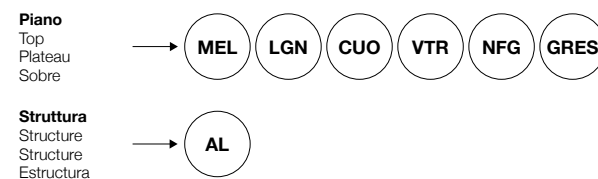

sculptural  
refined  
distinctive



Resistance, harmony and balance are the acknowledged qualities of things made to last. This is why Eracle has become a classic. In fact, its tables and desks are recognizable for their sophisticated shapes and innovative materials research.

The aluminium legs are its signature, thanks to their particular "diamond facet" that enhances Eracle elegance level.

For the table top, there are several materials to choose from. Italian melamine, leather, wood veneer, glass or porcelain tiles always framed by an aluminium profile.

Résistance, harmonie et équilibre sont les qualités reconnues aux choses destinées à durer dans le temps. C'est pour ce motif que le design d'Eracle est devenu un classique.

Ses tables et bureaux se distinguent par leurs formes raffinées et l'étude de matériaux innovants. Les pieds en aluminium sont la marque de fabrique de cette collection, grâce à leur facette particulière en "diamant" qui élève le niveau de sophistication.

Pour les plateaux, vous pouvez choisir parmi une large gamme de matériaux, à partir du mélaminé au bois, du cuir au verre, du grès cérame, toujours encadrés par un chant en aluminium.

La resistencia, la armonía y el equilibrio son las calidades que se reconocen a las cosas destinadas a durar en el tiempo.

Por esta razón, el diseño de Eracle se ha convertido en un clásico.

De hecho, sus mesas y escritorios se distinguen por sus formas refinadas y el estudio de materiales innovadores.

Las patas de aluminio son el signo de reconocimiento de esta colección, gracias a su particular faceta "diamante" que eleva el nivel de refinamiento.

Para los tableros, es posible elegir entre numerosos materiales, desde melamina hasta madera, desde cuero hasta vidrio e incluso gres porcelánico, siempre enmarcados por un marco de aluminio.





# Eracle. collection



**Sale riunioni**  
Meeting rooms  
Salles de réunion  
Salas de reuniones



**Uffici privati**  
Private offices  
Bureaux privés  
Oficinas privadas



**Tavolini**  
Coffee tables  
Tables basses  
Mesitas







**1. Scrivania** | Desk | Bureau | Mesa **Fin.** AK, AL  
L 240 P 120 cm | W 94 1/2" D 47 1/4"

**2. Tavolo** | Table | Table | Mesa **Fin.** JN, AL  
L 300 P 120 cm | W 118 1/8" D 47 1/4"

**3. Composizione** | Composition | Composition | Composición  
**Fin.** NT, AL L 600 P 120 cm | W 236 1/4" D 47 1/4"

**4. Scrivania** | Desk | Bureau | Mesa **Fin.** NT, AL  
L 200 P 100 cm | W 78 3/4" D 39 3/8"  
**Tavolo** | Table | Table | Mesa **Fin.** NT, AL  
P/L 200 cm | W 78 3/4"



**Piano** | Desk top | Plateau | Sobre

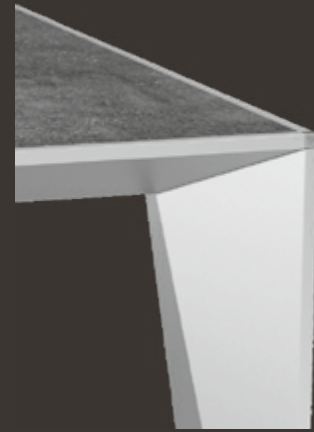

**Piani in legno/melaminico/  
cuoio/vetro/gres**  
Desk tops - wood veneer  
Italian melamine/leather/glass/  
porcelain tiles  
Plateaux en bois/melaminé/  
cuir/verre/grès cérame  
Sobre de madera/melaminico/  
cuero/vidrio/gres porcelánico

**Gambe** | Legs | Pieds | Patas

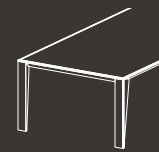

**Gambe angolari - alluminio/cuoio**  
Corner legs - aluminium/leather  
Piètements d'angle - aluminium/cuir  
Patas angulares - aluminio/cuero

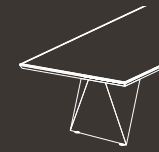

**Basamento a diamante - alluminio**  
Diamond-shaped base - aluminium  
Base à diamant - aluminium  
Base en forma de diamante - aluminio

**Scrivanie** | Desks | Bureaux | Mesas



L 200/240 - P 100/120 cm  
W 78 3/4"-94 1/2" - D 39 3/8"-47 1/4"

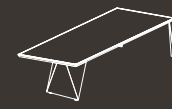

L 240 - P 120 cm  
W 94 1/2" - D 47 1/4"

**Dattilo** | Returns | Retours | Alas

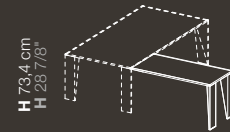

L 100/120 - P 60/80 cm  
W 39 3/8"-47 1/4" - D 23 5/8"-31 1/2"

**Tavoli riunione** | Meeting tables | Tables de réunion | Mesas de juntas



L/P 120/150/200 cm  
W/D 47 1/4"-59"-78 3/4"



L/P 150 cm  
W/D 59"

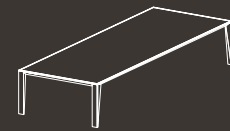

L 240/300 - P 120 cm  
W 94 1/2"-118 1/8" - D 47 1/4"

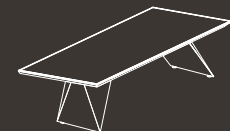
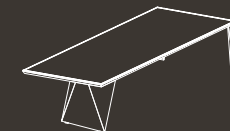

**Tavolini da caffè** | Coffee tables | Tables basses | Mesitas



L/P 60 cm  
W/D 23 5/8"



L 120 - P 60 cm  
W 47 1/4" - D 23 5/8"



3.



4.



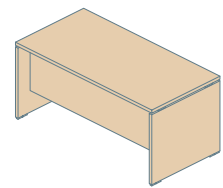

80  
Atlante

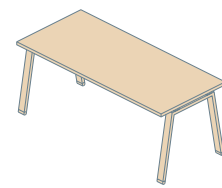

88  
Atreo

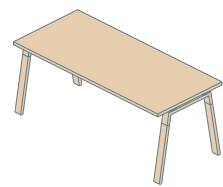

98  
Atreo Wood

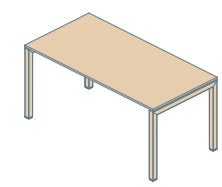

106  
Italo\_forty

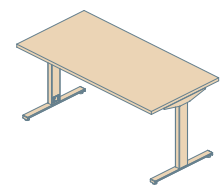

114  
Ortho

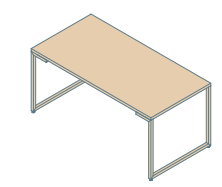

122  
Ibis

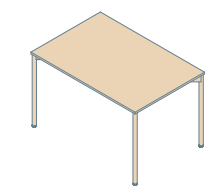

130  
Rendez-Vous

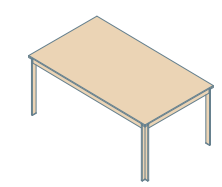

138  
Zefiro

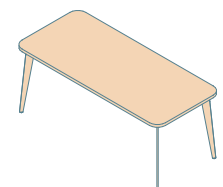

146  
Blade

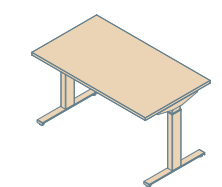

154  
Crono



# operativi

Workstations  
Opératifs  
Operativos



# Atlante

**Atlante è un sistema di workstation composto da pareti strutturali, disponibili anche nella versione di altezza 120 cm con applicazione in tessuto acustico puntaspilli, attrezzabili con corpetti contenitori ad ante scorrevoli in acrilico e melaminico.**

**Atlante propone anche workstation sagomate a 90° e 120° e contenitori laterali H 120 cm, utili per la archiviazione di documenti di frequente consultazione. Ciascun elemento (gamba, top, parete, struttura e fronte dei contenitori) può avere un colore diverso permettendo una forte personalizzazione.**

Atlante is a workstation system made of structural panels, also available in the version 120 cm (47 1/4") high with fabric acoustic/tackable application. It can be accessorized by overheads with acrylic or Italian melamine sliding doors.

Atlante also offers 90° and 120° shaped workstations and H 120 cm (47 1/4") lateral storage units, useful for storing daily paperwork. Each component (leg, top, panel and storage fronts) can have a different color allowing a wide customization.

Atlante est un système de poste de travail composé de panneaux structuraux, également disponibles dans la version avec panneaux de 120 cm de hauteur avec application en tissu acoustique punaisable, peuvent être équipés de modules-rangement avec porte coulissante en acrylique et mélaminé.

Atlante propose également des postes de travail façonnés à 90° et 120° et des conteneurs latéraux H 120 cm, utiles pour l'archivage de documents fréquemment consultés. Chaque élément (pied, plateau, panneau, structure et façade des conteneurs) peut avoir une couleur différente permettant une forte personnalisation.

Atlante es un sistema de estaciones de trabajo compuesto por biomboes estructurales, disponibles también en la versión con una altura de 120 cm y aplicación en tejido acústico pinchable, se pueden equipar con contenedores con puertas corredizas en acrílico y melaminico.

Atlante propone también workstations de 90° y 120° y contenedores laterales H 120 cm, útiles para el archivo de documentos que se consultan con frecuencia. Cada elemento (pata, pared, estructura y frente de los contenedores) puede tener un color diferente permitiendo una fuerte personalización.

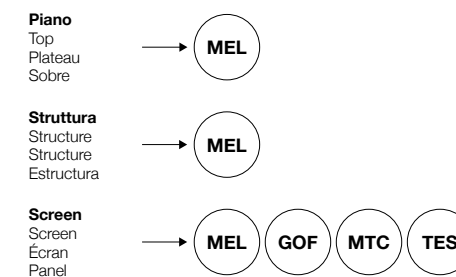

adaptable  
modular  
extensive





# Atlante. collection



**Sale riunioni**  
Meeting rooms  
Salles de réunion  
Salas de reuniones



**Tavolini**  
Coffee tables  
Tables basses  
Mesitas



**Uffici privati**  
Private offices  
Bureaux privés  
Oficinas privadas



**Workstations**  
Workstations  
Poste de travail  
Estación de trabajo

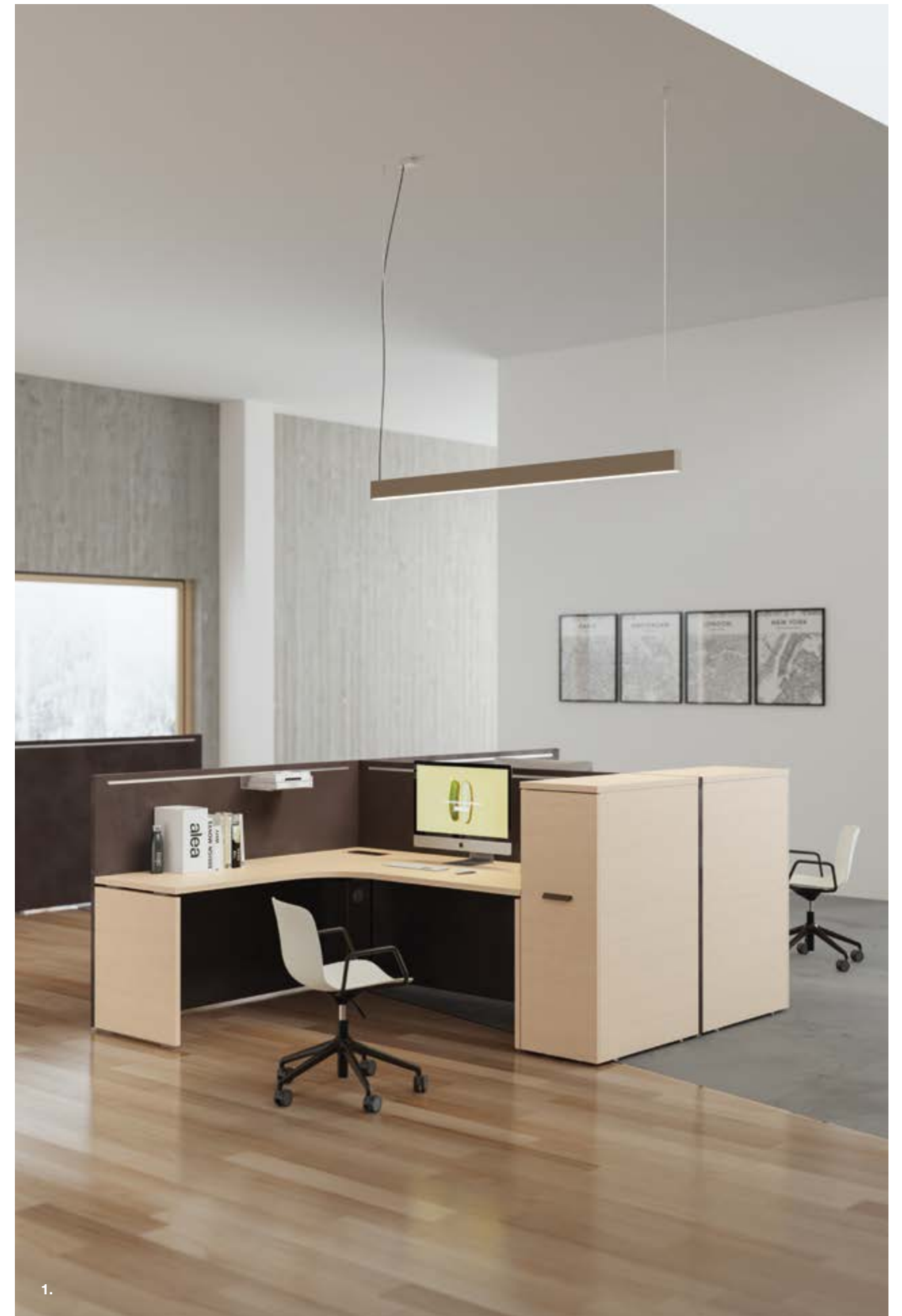





2.



3.

**1. Workstation 90°** | 90° workstation | Station de travail 90° | Estación de trabajo 90° **Fin.** MC, MZ, EZ  
**L** 160 **P** 160 cm | **W** 63" **D** 63"

**2. Workstation 90°** | 90° workstation | Station de travail 90° | Estación de trabajo 90° **Fin.** MN, MC  
**L** 160 **P** 160 cm | **W** 63" **D** 63"

**3. Scrivania** | Desk | Bureau | Mesa **Fin.** ME  
**L** 180 **P** 90 cm | **W** 70 7/8" **D** 35 3/8"  
**Dattilo** | Return | Retour | Ala  
**L** 120 **P** 60 cm | **W** 47 1/4" **D** 23 5/8"  
**Tavolino da caffè** | coffee table | table basse | mesita  
**L/P** 60 cm | **W/D** 23 5/8"

**4. Composizione** | Composition | Composition | Composición **Fin.** MN, MC **L** 360 **P** 400 cm | **W** 141 3/4" **D** 157 1/2"

**5. Composizione** | Composition | Composition | Composición **Fin.** MN, MI **L** 530 **P** 300 cm | **W** 208 5/8" **D** 118 1/8"



4.





**Piani e gambe** | Desk tops and legs | Plateaux et pieds | Sobres y patas

**Spessore 3 cm**  
3 cm (1 1/8") thick  
3 cm d'épaisseur  
3 cm de espesor

**Gamba esterna filopiano**  
Side flush-fitting panel leg  
Pied terminaux à fleur plateau  
Costado rasado tapa mesas

**Gamba sottopiano**  
Panel leg under top  
Pied sous plateaux  
Costado bajo tapa mesas

**Paretina con pannello in tessuto puntaspilli applicato**  
Side leg with tackable panel applied  
Cloison terminal avec panneau punaisable  
Biombo terminales con panel en tejido pinchable

**Scrivanie** | Desks | Bureaux | Mesas

H 73.4 cm  
H 28 7/8"  
L 120/140/160/180/200 - P 80/90 cm  
W 47 1/4"-55 1/8"-63"-70 7/8"-78 3/4" - D 31 1/2"-35 3/8"

**Dattilo** | Returns | Retours | Alas

H 73.4 cm  
H 28 7/8"  
L 80/100/120/140/160/180/200 - P 60 cm  
W 31 1/2"-39 3/8"-47 1/4"-55 1/8"-63"-70 7/8"-78 3/4" - D 23 5/8"

**Tavoli riunione** | Meeting tables | Tables de réunion | Mesas de juntas

H 73.4 cm  
H 28 7/8"  
Ø 100/120 cm  
Ø 39 3/8"-47 1/4"  
L 210/280 - P 120 cm  
W 82 5/8"-110 1/4" - D 47 1/4"

**Tavolini da caffè** | Coffee tables | Tables basses | Mesitas

H 40 cm  
H 15 3/4"  
L/P 60 cm  
W/D 23 5/8"  
L 120 - P 60 cm  
W 47 1/4" - D 23 5/8"

**Esempi composizioni** | Composition example | Exemples de compositions | Ejemplos de composiciones

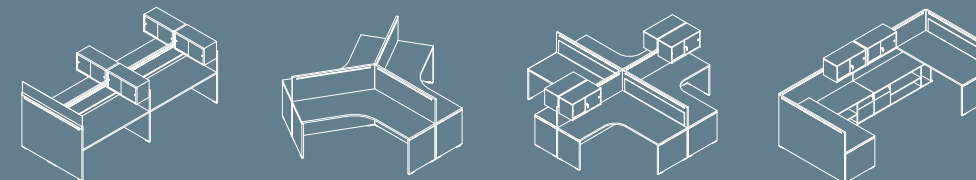



# Atreo

**Atreo è un sistema molto versatile che offre soluzioni ideali per le postazioni lavoro singole o multiple.**

**I contenitori laterali strutturali possono essere dotati di cuscino. Le gambe hanno varie forme, aperte o ad anello. Sono disponibili anche workstation con piani sagomati e angoli arrotondati.**

**Peculiarità di Atreo sono anche le console, disponibili sia nella versione mobile che fissa, offrono ampio spazio per agganciare i monitor e nascondere il cablaggio.**

Atreo is a versatile system that offers ideal solutions for single or multiple workstations.

Structural side storage units can be equipped with a cushion. Legs are available in various shapes, open or loop legs. Workstations with shaped tops and rounded corners are also available.

Atreo peculiarity are also the media consoles, available in both mobile and fixed versions, providing enough space to mount monitors and hide wiring.

Atreo est un système très polyvalent qui offre des solutions idéales pour des postes de travail individuels ou multiples.

Les meubles retour structurels peuvent être équipés d'un coussin. Les piétements existent en 3 versions : trapèze, droit ou anneau. Des postes de travail avec des plateaux façonnés avec coins arrondis sont également disponibles.

Particularités d'Atreo sont également les cloisons techniques, disponibles dans les versions mobile et fixe, ils offrent beaucoup d'espace pour connecter les écrans et masquer le câblage.

Atreo es un sistema muy versátil que ofrece soluciones ideales para estaciones de trabajo individuales o multiples.

Los muebles laterales estructurales se pueden equipar con un cojín. Las patas tienen varias formas, abiertas o en un anillo. Están disponible también estaciones de trabajo con sobres en forma y esquinas redondeadas.

Peculiaridades de Atreo también son las consolas, disponibles tanto en la versión móvil como fija y ofrecen un amplio espacio para conectar monitores y ocultar el cableado.

Piano  
Top  
Plateau  
Sobre



MEL

Struttura  
Structure  
Structure  
Estructura



EPX

Screen  
Screen  
Ecran  
Panel



MEL

GOF

MTC

TES

OSB

must-have  
shapes  
fresh





# Atreo. collection



**Tavolini**  
Coffee tables  
Tables basses  
Mesitas



**Contenitori**  
Storage  
Rangements  
Contenedores



**Sale riunioni**  
Meeting rooms  
Salles de réunion  
Salas de reuniones



**Condivisione**  
Sharing  
Partage  
Compartir



**Uffici privati**  
Private offices  
Bureaux privés  
Oficinas privadas



**Workstations**  
Workstations  
Poste de travail  
Estación de trabajo



1.



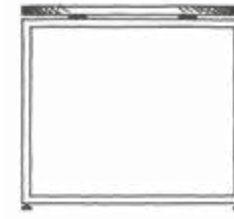





6.

- 1. Bench** | Bench | Bench | Bench **Fin.** MN  
L 200 P 163 cm | W 78 3/4" D 64 1/8"
- 2. Bench** | Bench | Bench | Bench **Fin.** MN, MD, FU, EI  
L 400 P 163 cm | W 70 7/8" D 70 7/8"  
**Mobile di servizio** | Service unit | Meuble retour | Mueble de servicio  
L 160 P 58 cm | W 63" D 22 7/8"
- 3. Bench** | Bench | Bench | Bench **Fin.** MK, OSB, EO  
L 200 P 163 cm | W 78 3/4" D 64 1/8"
- 4. Tavolo** | Table | Table | Mesa **Fin.** MO, ES  
L 420 P 120 cm | W 165 3/8" D 47 1/4"
- 5. Composizione 120°** | 120° composition | Composition 120° |  
Composición 120° **Fin.** MT, ET  
L 680 P 360 cm | W 267 3/4" D 141 3/4"
- 6. Scrivania** | Desk | Bureau | Mesa **Fin.** ME, EI  
L 200 P 90 cm | W 78 3/4" D 35 3/8"  
**Mobile di servizio** | Service unit | Meuble retour | Mueble de servicio  
L 160 P 58 cm | W 63" D 22 7/8"
- 7. Bench** | Bench | Bench | Bench **Fin.** ML, OSB, EN  
L 600 P 163 cm | W 236 1/4" D 64 1/8"
- 8. Console** | Console | Console | Consola **Fin.** ML, OSB, EN  
L 180 P 90 H 105 cm | W 70 7/8" D 35 3/8" H 41 3/8"



**Piani** | Desk tops | Plateaux | Sobres

Spessore 3 cm | 3 cm (1 1/8") thick | 3 cm d'épaisseur | 3 cm de espesor



**Con angoli dritti**  
With straight corners  
Avec coins droits  
Con esquinas rectas



**Con angoli raggati**  
With rounded corners  
Avec coins arrondis  
Con esquinas redondeadas

**Gambe** | Legs | Pieds | Patas

Sezione 7x3 cm | Section 7x3 cm (2 3/4"x1 1/8") | Section 7x3 cm | Sección 7x3 cm



**A cavalletto**  
A-shape  
Tréteau  
Cabalete

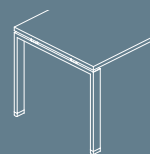

**A ponte**  
Straight  
Droit  
Recta

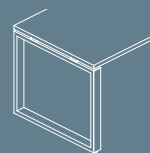

**Ad anello**  
Closed loop  
En anneau  
Anillo

**Scrivanie** | Desks | Bureaux | Mesas

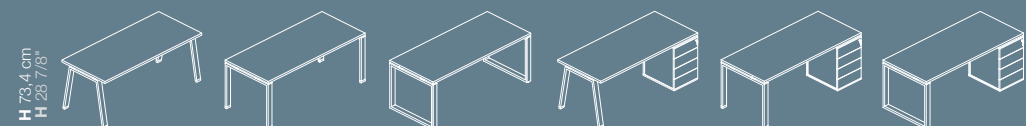

H 73,4 cm  
H 28 7/8"

L 120/140/160/180/200 - P 80/90 cm  
W 47 1/4"-55 1/8"-63"-70 7/8"-78 3/4" - D 31 1/2"-35 3/8"

**Dattilo** | Returns | Retours | Alas

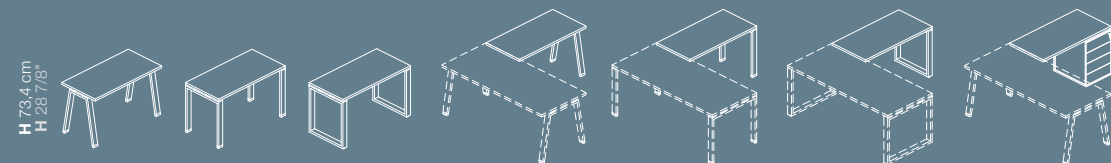

H 73,4 cm  
H 28 7/8"

L 80/100/120 - P 60 cm  
W 31 1/2"-39 3/8"-47 1/4" - D 23 5/8"

**Tavoli riunione** | Meeting tables | Tables de réunion | Mesas de juntas

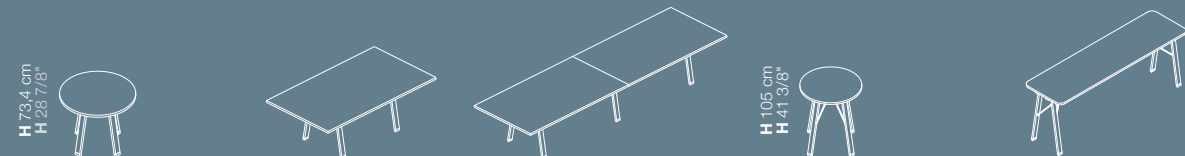

H 73,4 cm  
H 28 7/8"

H 105 cm  
H 41 3/8"

Ø 90/100/120/130/150 cm  
Ø 35 3/8"-39 3/8"-47 1/4"-  
51 1/8"-59"

L 210/280 - P 120 cm  
W 82 5/8"-110 1/4" -  
D 47 1/4"

L 420/560 - P 120 cm  
W 165 3/8"-220 1/2" - D 47 1/4"

Ø 90/100/120/130/150 cm  
Ø 35 3/8"-39 3/8"-47 1/4"-  
51 1/8"-59"

L 140/160/180/200/220/240/260/280 - P 60/80 cm  
W 55 1/8"-63"-70 7/8"-78 3/4"-86 5/8"-94 1/2"-102  
3/8"-110 1/4" - D 23 5/8"-31 1/2"

**Tavolini da caffè** | Coffee tables | Tables basses | Mesitas



H 40 cm  
H 15 3/4"

L/P 60 cm  
W/D 23 5/8"

L 120 - P 60 cm  
W 47 1/4" - D 23 5/8"

**Mobili di servizio** | service units | meuble retour | muebles de servicio



H 54 cm  
H 21 1/4"

L 160 - P 58 cm  
W 63" - D 22 7/8"

**Esempi composizioni** | Composition example | Exemples de compositions | Ejemplos de composiciones

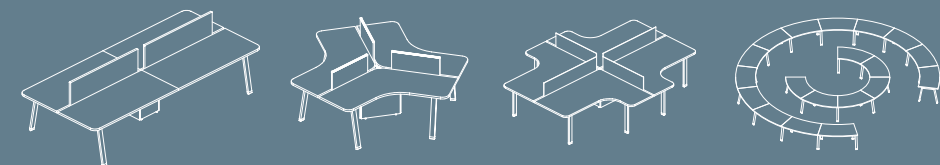





# Atreo Wood

**Il sistema operativo Atreo con gamba metallica presenta ora una interessante opzione per la versione con gamba a cavalletto.**

**La parte inferiore della gamba è disponibile con inserto in legno massello rovere chiaro, a creare una nuova originale combinazione di materiali complementari.**

Atreo operative system with metal leg now has an interesting option for the version with A-shaped leg. The lower portion of the leg is available in light oak solid wood, to create a new, original mix of blending materials.

La collection Atreo avec sa structure métallique est maintenant doté d'une option intéressante avec la version pied trapèze

Ces piétements sont équipés d'un insert en ébénisterie en finition chêne naturel, en créant une combinaison originale de matériaux complémentaires.

El sistema operativo Atreo con pata metálica presenta ahora una opción interesante para la versión con pata de caballete.

La parte inferior de la pata está disponible con inserción de madera maciza roble claro, para crear una nueva combinación original de materiales complementarios.

**Piano**  
Top  
Plateau  
Sobre



**Struttura**  
Structure  
Structure  
Estructura



**Screen**  
Screen  
Écran  
Panel



organic  
balance  
curves





# Atreo Wood. collection



**Uffici privati**  
Private offices  
Bureaux privés  
Oficinas privadas



**Contenitori**  
Storage  
Rangements  
Contenedores



**Condivisione**  
Sharing  
Partage  
Compartir



**Workstations**  
Workstations  
Poste de travail  
Estación de trabajo



**Salas riunioni**  
Meeting rooms  
Salles de réunion  
Salas de reuniones



1.







2.



3.

1. **Bench** | Bench | Bench | Bench **Fin.** MN, EB  
 L 180 P 163 cm | W 70 7/8" D 64 1/8"

2. **Tavolo** | Table | Table | Mesa **Fin.** MZ, EZ  
 L 280 P 120 cm | W 110 1/4" D 47 1/4"

3. **Tavolo** | Table | Table | Mesa **Fin.** MI, EO, MZ, EZ, MT, ET  
 Ø 120 H 105 cm | Ø 47 1/4" H 41 3/8"

4. **Tavolo** | Table | Table | Mesa **Fin.** MI, EO  
 L 280 P 80 H 105 cm | W 110 1/4" D 31 1/2" H 41 3/8"

5. **Bench** | Bench | Bench | Bench **Fin.** MI, EB  
 L 320 P 163 cm | W 126" D 64 1/8"



4.

103





5.

**Piani** | Desk tops | Plateaux | Sobres

**Spessore 3 cm** | 3 cm (1 1/8") thick | 3 cm d'épaisseur | 3 cm de espesor



**Con angoli dritti**  
With straight corners  
Avec coins droits  
Con esquinas rectas



**Con angoli raggiati**  
With rounded corners  
Avec coins arrondis  
Con esquinas redondeadas

**Gambe** | Legs | Pieds | Patas

**Sezione 7x3 cm** | Section 7x3 cm (2 3/4"x1 1/8") | Section 7x3 cm | Sección 7x3 cm

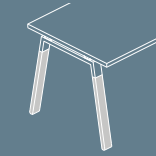

**A cavalletto**  
A-shape  
Tréteau  
Caballete

**Scrivanie** | Desks | Bureaux | Mesas

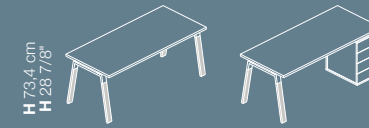

H 73,4 cm  
H 28 7/8"

L 120/140/160/180/200 - P 80/90 cm  
W 47 1/4"/55 1/8"/63"/70 7/8"/78 3/4" - D 31 1/2"/35 3/8"

**Dattilo** | Returns | Retours | Alas

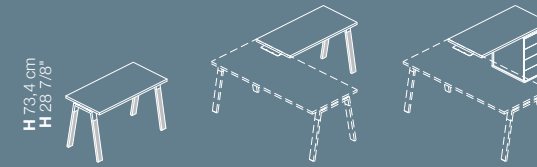

H 73,4 cm  
H 28 7/8"

L 80/100/120 - P 60 cm  
W 31 1/2"/39 3/8"/47 1/4" - D 23 5/8"

**Tavoli riunione** | Meeting tables | Tables de réunion | Mesas de juntas

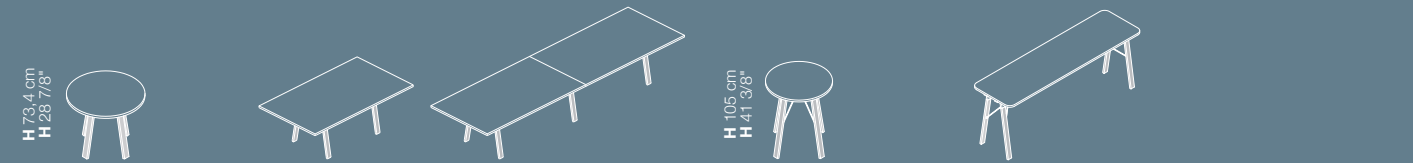

H 73,4 cm  
H 28 7/8"

H 105 cm  
H 41 3/8"

Ø 90/100/120/130/150 cm    L 210/280 - P 120 cm    L 420/560 - P 120 cm    Ø 90/100/120/130/150 cm    L 140/160/180/200/220/240/260/280 - P 60/80 cm  
Ø 35 3/8"/39 3/8"/47 1/4"/51 1/8"/59"    W 82 5/8"/110 1/4"    W 165 3/8"/220 1/2"    Ø 35 3/8"/39 3/8"/47 1/4"/51 1/8"/59"    W 55 1/8"/63"/70 7/8"/78 3/4"/86 5/8"/94 1/2"/102 3/8"/110 1/4"    D 23 5/8"/31 1/2"

**Mobili di servizio** | Service units | Meuble retour | Muebles de servicio



H 54 cm  
H 21 1/4"

L 160 - P 58 cm  
W 63" - D 22 7/8"



# Italo\_forty

**Italo\_forty è un sistema dalle sorprendenti prerogative tecniche ma dai costi contenuti.**

**Il sistema si compone di una struttura metallica trave/cavalletto di supporto a piani di spessore 18 mm.**

**I piani possono essere sia fissi che traslabili, permettendo così un comodo accesso al cestello per la gestione dei cavi. Italo\_forty consente inoltre di realizzare tavoli con campata sino a 300 cm senza l'ausilio di supporti intermedi.**

Italo\_forty system combines great technical features with cost efficient components.

A metal structure with horizontal beams and straight legs, supports tops 18 mm (3/4") thick.

Tops can be either fixed or sliding, allowing easy access to the basket for cable management. With Italo\_forty it is also possible to create tables up to 300 cm (118 1/8") long, without the use of intermediate supports.

Italo\_forty est un système aux surprenantes caractéristiques techniques mais au prix contenu.

Le système se compose d'une structure métallique poutre/pied droit à support de plateaux de 18 mm d'épaisseur.

Les plateaux peuvent être fixes ou mobiles, ce qui permet un accès facile au panier pour la gestion des câbles. Italo\_forty permet également de créer des tables avec largeur jusqu'à 300 cm sans l'aide de supports intermédiaires.

Italo\_forty es un sistema de sorprendentes características técnicas a un precio razonable.

El sistema consta de una estructura metálica de patas/vigas que soporta superficies de 18 mm de espesor.

Los sobres pueden ser tantos fijos como móviles y permiten así un cómodo acceso a la viga por el manejo de los cables. Italo\_forty permite además de realizar mesas hasta los 300 cm de largo sin el uso de apoyos intermedios.

**Piano**  
Top  
Plateau  
Sobre



**Struttura**  
Structure  
Structure  
Estructura



**Screen**  
Screen  
Ecran  
Panel



easy  
essential  
linear





# Italo\_forty. collection



**Uffici privati**  
Private offices  
Bureaux privés  
Oficinas privadas



**Workstations**  
Workstations  
Poste de travail  
Estación de trabajo



**Sale riunioni**  
Meeting rooms  
Salles de réunion  
Salas de reuniones







1. **Bench** | Bench | Bench | Bench **Fin.** MD, EB  
L 160 P 163 cm | W 63" D 64 1/8"

2. **Bench** | Bench | Bench | Bench **Fin.** MK, MI, EB  
L 360 P 163 cm | W 141 3/4" D 64 1/8"

3. **Tavolo** | Table | Table | Mesa **Fin.** MZ, EE  
L 280 P 123 cm | W 110 1/4" D 48 3/8"

4. **Tavolo** | Table | Table | Mesa **Fin.** MW, EB  
L 960 P 123 cm | W 378" D 48 3/8"







3.



4.

**Piani** | Desk tops | Plateaux | Sobres

**Gambe** | Legs | Pieds | Patas

**Sezione 4x4 cm** | Section 4x4 cm (1 5/8" x 1 5/8") | Section 4x4 cm | Sección 4x4 cm



**Melaminico spessore 3 cm/vetro spessore 0,8 cm**  
 Italian melamine 3 cm (1 1/8") thick/glass 0,8 cm (1/4") thick  
 Melaminé 3 cm d'épaisseur/verre 0,8 cm d'épaisseur  
 Melaminico 3 cm de espesor/vidrio 0,8 cm de espesor

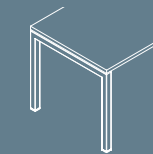

**Sezione quadrata**  
 Square section  
 Section carrée  
 Sección cuadrada

**Scrivanie** | Desks | Bureaux | Mesas

**Dattilo** | Returns | Retours | Alas

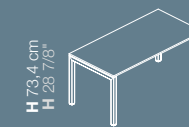

H 73,4 cm  
 H 28 7/8"

**L** 100/120/140/160/180/200 - **P** 80/90 cm  
**W** 39 3/8"-47 1/4"-55 1/8"-63"-70 7/8"-78 3/4" -  
**D** 31 1/2"-35 3/8"

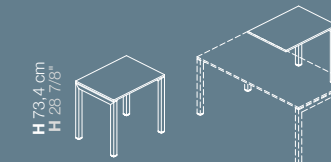

H 73,4 cm  
 H 28 7/8"

**L** 80/100/120 - **P** 60 cm  
**W** 31 1/2"-39 3/8"-47 1/4" - **D** 23 5/8"

**Tavoli riunione** | Meeting tables | Tables de réunion | Mesas de juntas

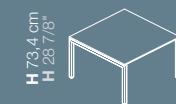

H 73,4 cm  
 H 28 7/8"

**L** 120/160 - **P** 123/163 cm  
**W** 47 1/4"-63" - **D** 48 3/8"-64 1/8"



**L** 210/240/300 - **P** 123 cm  
**W** 82 5/8"-94 1/2"-118 1/8" - **D** 48 3/8"

**Esempi composizioni** | Composition example | Exemples de compositions | Ejemplos de composiciones

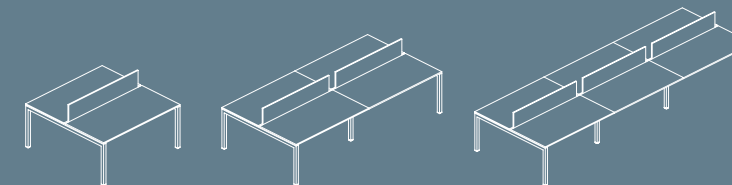





# Ortho

**Il sistema di scrivanie Ortho si caratterizza per la possibilità di scegliere piani da 18 o 30 mm.**

**Le due gambe sono collegate da una trave strutturale. Attraverso il montante il cablaggio transita da terra fino al piano scrivania, entrando e fuoriuscendo da appositi accessi passacavi.**

The Ortho desk system features the possibility to choose 18 or 30 mm (3/4" or 1 1/8") thick tops.

The two legs are connected by a structural metal beam. Through the upright, wires transit from the floor up to the desk top, coming in and out from dedicated grommets.

Le système de bureau Ortho se caractérise par la possibilité de choisir des plateaux avec un épaisseur de 18 ou 30 mm. Le câblage passe du sol au bureau à travers le montant, pour entrer ou sortir par les accès appropriés.

El sistema de mesas Ortho se caracteriza para la posibilidad de elegir sobres de 18 o 30 mm de grosor. Las dos patas están conectadas entre ellas por una viga estructural. A través de la columna vertical, el cableado transita del suelo hasta el sobre mesa, entrando y saliendo de los apropiados huecos pasacables.

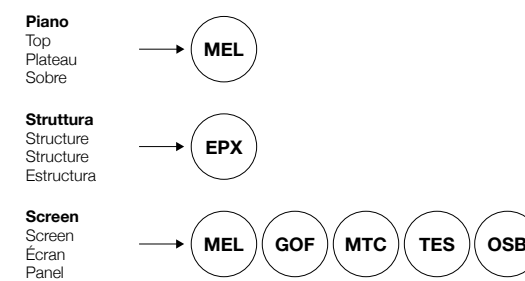

simple  
technical  
pragmatic





# Ortho. collection



**Workstations**  
Workstations  
Poste de travail  
Estación de trabajo



**Uffici privati**  
Private offices  
Bureaux privés  
Oficinas privadas



**Sale riunioni**  
Meeting rooms  
Salles de réunion  
Salas de reuniones



**Divisori**  
Dividers  
Séparateurs  
Separadores  
→ p. 198







3.



4.

**1. Composizione 90°** | 90° composition | Composition 90° |  
Composición 90° **Fin.** MN, EB  
**L** 363 **P** 363 cm | **W** 142 7/8" **D** 142 7/8"

**2. Scrivania** | Desk | Bureau | Mesa **Fin.** ME, EI  
**L** 200 **P** 90 cm | **W** 78 3/4" **D** 35 3/8"  
**Dattilo** | Return | Retour | Ala  
**L** 100 **P** 60 cm | **W** 39 3/8" **D** 23 5/8"

**3. Scrivania** | Desk | Bureau | Mesa **Fin.** MN, MK, MJ, ED  
**L** 180 **P** 80 cm | **W** 70 7/8" **D** 31 1/2"

**4. Tavolo** | Table | Table | Mesa **Fin.** ML, EN  
**L** 200 **P** 120 cm | **W** 78 3/4" **D** 47 1/4"

**5. Tavolo** | Table | Table | Mesa **Fin.** MK, EB  
**L** 600 **P** 120 cm | **W** 236 1/4" **D** 47 1/4"

**6. Scrivania** | Desk | Bureau | Mesa **Fin.** MT, ET  
**L** 160 **P** 80 cm | **W** 63" **D** 31 1/2"



5.





Piani e strutture | Desk tops and structures | Plateaux et structures | Sobres y estructuras

**Spessore 3 cm**  
3 cm thick (1 1/8")  
3 cm d'épaisseur  
3 cm de espesor

**Spessore 1,8 cm**  
1,8 cm thick (3/4")  
1,8 cm d'épaisseur  
1,8 cm de espesor



**Struttura in metallo elettrificata, regolabile in altezza manualmente**  
Electrified metal structure, manually height-adjustable  
Structure en métal électrifiée, réglable manuellement en hauteur  
Estructura metálica electrificada, regulable manualmente en altura

Piano da 18 mm | 18 mm (3/4") top | Plateau ép. 18 mm | Sobre mesa de 18 mm de grosor



**A) Struttura fissa, B) Struttura regolabile**  
A) Fixed structure, B) Height-adjustable structure  
A) Structure fixe, B) Structure réglable en hauteur  
A) Estructura con altura fija, B) Estructura con altura regulable

Piano da 30 mm | 30 mm (1 1/8") top | Plateau ép. 30 mm | Sobre mesa de 30 mm de grosor



**A) Struttura fissa, B) Struttura regolabile**  
A) Fixed structure, B) Height-adjustable structure  
A) Structure fixe, B) Structure réglable en hauteur  
A) Estructura con altura fija, B) Estructura con altura regulable

Scrivanie | Desks | Bureaux | Mesas

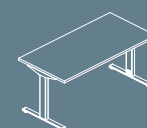

L 120/140/160/180/200 - P 80/90 cm  
W 47 1/4"-55 1/8"-63"-70 7/8"-78 3/4" - D 31 1/2"-35 3/8"

Dattilo | Returns | Retours | Alas



L 80/100/120 - P 60 cm  
W 31 1/2"-39 3/8"-47 1/4" - D 23 5/8"

Workstation | Workstations | Workstation | Workstation

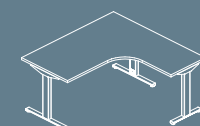

L 160/180 - P 160/180 cm  
W 63"-70 7/8" - D 63"-70 7/8"

Paretine | full-height panels | cloisons | biombos



L 60/70/80/90/100 cm  
W 23 5/8"-27 1/2"-31 1/2"-35 3/8"-39 3/8"

Tavoli riunione | Meeting tables | Tables de réunion | Mesas de juntas

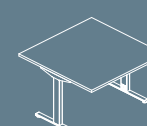

L/P 120 cm  
W/D 47 1/4"

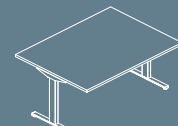

L 200 - P 120 cm  
W 78 3/4" - D 47 1/4"

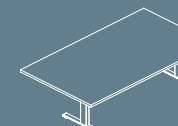

L 210/280 - P 120 cm  
W 82 5/8"-110 1/4" - D 47 1/4"



# Ibis

**Ibis ha una struttura portante leggera ed elegante.**

**Il suo design è caratterizzato dalle gambe ad anello piegate verso l'interno, realizzate con un profilo in metallo a sezione quadrata di 30 mm.**

**Tra le caratteristiche architettoniche principali troviamo le grandi superfici di lavoro singole e doppie che vanno a coprire le cassettiere strutturali, disponibili in diverse larghezze. Un altro dettaglio unico di Ibis sono i contenitori laterali che possono essere sospesi a giorno, oppure indipendenti con vani sia chiusi che aperti.**

Ibis has a light and elegant supporting structure.

Its design features ring legs folded towards the inside manufactured from steel square section 30 mm (1 1/8") thick.

Among the main architectural features we find the large single and double work surfaces that cover structural drawers, available in different widths. Other unique details are the side storage units that can be hanging or freestanding.

Ibis a une structure porteuse légère et élégante.

Le délicat travail de pliage du piétement à section carrée, 30 mm, lui confère un design pur et élégant.

Parmi les principales caractéristiques architecturales, on peut citer les grandes surfaces de travail simples et doubles qui recouvrent les éléments structuraux des tiroirs, disponibles en différentes largeurs. Un autre détail unique d'Ibis sont les rangements latéraux suspendus avec compartiments ouverts ou indépendants.

Ibis tiene una estructura de soporte ligera y elegante. Su diseño se caracteriza por la pata de anillo plegado hacia el interior, realizada con un perfil de acero de sección cuadrada de 30 mm.

Entre las principales características arquitectónicas se encuentran grandes superficies de trabajo individuales y dobles que cubren las cajoneras estructurales, disponibles en diferentes anchos. Otro detalle de Ibis son los contenedores laterales que pueden ser abiertos y colgados a la mesa o independientes con módulos cerrados y abiertos.

**Piano**  
Top  
Plateau  
Sobre



**Struttura**  
Structure  
Structure  
Estructura



**Screen**  
Screen  
Ecran  
Panel



slim  
minimalistic  
linear





# Ibis. collection



**Condivisione**  
Sharing  
Partage  
Compartir



**Contenitori**  
Storage  
Rangements  
Contenedores



**Workstations**  
Workstations  
Poste de travail  
Estación de trabajo



**Salae riunioni**  
Meeting rooms  
Salles de réunion  
Salas de reuniones



**Uffici privati**  
Private offices  
Bureaux privés  
Oficinas privadas



**Tavolini**  
Coffee tables  
Tables basses  
Mesitas



1.





2.

- 1. **Bench** | Bench | Bench | Bench **Fin.** MK, DH, YC  
L 190 P 160 cm | W 74 3/4" D 63"
- 2. **Bench** | Bench | Bench | Bench **Fin.** MI, MY, DI, EO  
L 230 P 160 cm | W 90 1/2" D 63"
- 3. **Scrivania** | Desk | Bureau | Mesa **Fin.** TR, ET  
L 200 P 90 cm | W 78 3/4" D 35 3/8"
- 4. **Bench** | Bench | Bench | Bench **Fin.** MI, OSB, EB  
L 320 P 160 cm | W 126" D 63"



3.





**Piani** | Desk tops | Plateaux | Sobres



**Melaminico spessore 3 cm/vetro spessore 0,8 cm**  
 Italian melamine 3 cm (1 1/8") thick/glass 0,8 cm (1/4") thick  
 Melaminé 3 cm d'épaisseur/verre 0,8 cm d'épaisseur  
 Melaminico 3 cm de espesor/vidrio 0,8 cm de espesor

**Gambe** | Legs | Pieds | Patas

**Sezione 3x3 cm** | Section 3x3 cm (1 1/8"x1 1/8") | Section 3x3 cm | Sección 3x3 cm

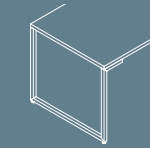

**Ad L**  
 L-shape  
 Pied en L  
 Pata en L



**A X**  
 X-shape  
 Pied en X  
 Pata en X

**Scrivanie** | Desks | Bureaux | Mesas

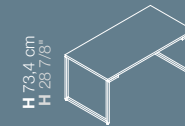

H 73,4 cm  
 H 28 7/8"

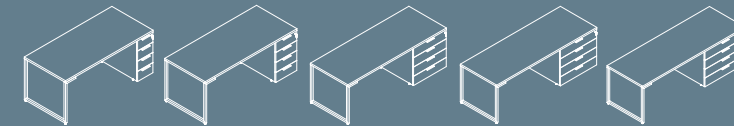

L 120/140/160/180/200 - P 80/90 cm  
 W 47 1/4"-55 1/8"-63"-70 7/8"-78 3/4" - D 31 1/2"-35 3/8"

**Disponibili con cassetteria strutturale in diverse dimensioni**  
 Available with structural drawer unit in various dimensions  
 Disponible avec caisson porteur en différentes dimensions  
 Disponible con bucs estructurales en diferentes tamaños

**Dattilo** | Returns | Retours | Alas



H 73,4 cm  
 H 28 7/8"

L 80/100/120 - P 60 cm  
 W 31 1/2"-39 3/8"-47 1/4" - D 23 5/8"

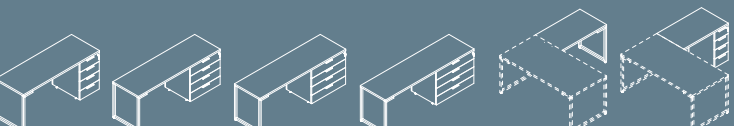

**Disponibili con cassetteria strutturale in diverse dimensioni**  
 Available with structural drawer unit in various dimensions  
 Disponible avec caisson porteur en différentes dimensions  
 Disponible con bucs estructurales en diferentes tamaños

**Bench** | Bench | Bench | Bench

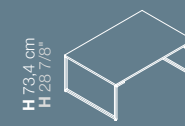

H 73,4 cm  
 H 28 7/8"

L 120/140/160/180/200 - P 120/160 cm  
 W 47 1/4"-55 1/8"-63"-70 7/8"-78 3/4" - D 47 1/4"-63"

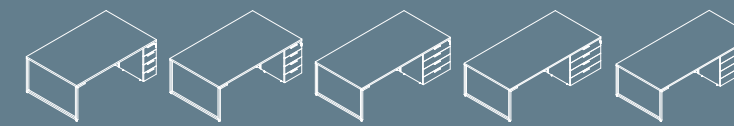

**Disponibili con cassetteria strutturale in diverse dimensioni**  
 Available with structural drawer unit in various dimensions  
 Disponible avec caisson porteur en différentes dimensions  
 Disponible con bucs estructurales en diferentes tamaños

**Tavoli riunione** | Meeting tables | Tables de réunion | Mesas de juntas



H 73,4 cm  
 H 28 7/8"

Ø 100/120/150 cm  
 Ø 39 3/8"-47 1/4"-59"



L/P 120 cm  
 W/D 47 1/4"

L 210/280 - P 120 cm  
 W 82 5/8"-110 1/4" - D 47 1/4"

L 350 - P 120 cm  
 W 137 3/4" - D 47 1/4"



H 105 cm  
 H 41 3/8"

Ø 100/120/150 cm  
 Ø 39 3/8"-47 1/4"-59"

**Tavolini da caffè** | Coffee tables | Tables basses | Mesitas



H 40 cm  
 H 15 3/4"

L/P 60 cm  
 W/D 23 5/8"



L 120 - P 60 cm  
 W 47 1/4" - D 23 5/8"

**Contenitore sospeso** | Hanging storage unit | Rangement suspendu | Contenedor suspendido

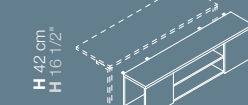

H 42 cm  
 H 16 1/2"

L 160 - P 33 cm  
 W 63" - D 13"

**Contenitori laterali** | Lateral storage units | Rangements latérales | Contenedores laterales



H 144 cm  
 H 56 3/4"

L 163/183/203 - P 53 cm  
 W 64 1/8"-72"-79 7/8" - D 20 7/8"



**Disponibili con cassetteria strutturale in diverse dimensioni**  
 Available with structural drawer unit in various dimensions  
 Disponible avec caisson porteur en différentes dimensions  
 Disponible con bucs estructurales en diferentes tamaños





# Rendez-Vous

**Rendez-Vous è stato progettato per agevolare la condivisione dello spazio. In un'epoca dove la flessibilità in termini di modi e luoghi diventa un must, questa collezione si apre a molteplici interpretazioni.**

**I tavoli hanno piani da 18 mm e gambe tubolari in metallo verniciato. Partono da un'altezza di 73,4 cm, che si può aumentare arrivando a 90 o 105 cm. Questo incremento avviene grazie ad una struttura di base addizionale, provvista di poggiapiedi, che si può colorare diversamente rispetto alle gambe e può essere aggiunta o rimossa a piacere.**

Rendez-Vous is designed to create collaboration spaces. In an age where flexibility in terms of ways and places is becoming a must, this collection is open to multiple interpretations.

Tables are composed by 18 mm (3/4") tops and tubular legs in painted metal. They start at a height of 73,4 cm (28 7/8"), which can be increased to 90 or 105 cm (35 3/8" or 41 3/8") thanks to an additional base frame with footrest, which can be painted in a different colour and can be added or removed as required.

Rendez-Vous est conçu pour créer des espaces de collaboration. À une époque où la flexibilité en termes de moyens et de lieux devient un must, cette collection est ouverte à de multiples interprétations.

Les tables sont composées de plateaux de 18 mm et de pieds tubulaires en métal peint. La première hauteur de la table est de 73,4 cm, qu'on peut augmenter jusqu'à 90 cm ou 105 cm. Ces dernières dimensions peuvent être atteints grâce à une structure additionnelle équipée de reposepieds, qui peut avoir une finition différente par rapport au pieds fixes. Ils pourront être ajoutés et enlevés à discrétion.

Rendez-Vous ha sido diseñado para facilitar el uso compartido del espacio. En una época en la que la flexibilidad en términos de modos y lugares se hace imprescindible, esta colección se abre a múltiples interpretaciones.

Las mesas tienen sobres de 18 mm y patas tubulares en metal pintado. Las mesas parten de una altura de 73,4 cm, que se puede aumentar alcanzando los 90 o 105 cm. Este aumento se produce gracias a una estructura básica adicional, equipada con reposapiés, que se puede colorar de un color diferente de las patas y se puede añadir o eliminar a voluntad.

**Piano**  
Top  
Plateau  
Sobre



**Struttura**  
Structure  
Structure  
Estructura



**Screen**  
Screen  
Ecran  
Panel



light  
flexible  
stylish





# Rendez-Vous. collection



**Workstations**  
Workstations  
Poste de travail  
Estación de trabajo



**Condivisione**  
Sharing  
Partage  
Compartir



**Uffici privati**  
Private offices  
Bureaux privés  
Oficinas privadas



**Salae riunioni**  
Meeting rooms  
Salles de réunion  
Salas de reuniones







- 1. **Tavolo** | Table | Table | Mesa **Fin.** MD, EI  
L 300 P 100 cm | W 118 1/8" D 39 3/8"
- 2. **Tavolo** | Table | Table | Mesa **Fin.** MD, YB  
L 160 P 80 cm | W 63" D 31 1/2"  
L 220 P 80 H 105 cm | W 86 5/8" D 31 1/2" H 41 3/8"
- 3. **Tavolo** | Table | Table | Mesa **Fin.** MT, ET, EO  
Ø 120 H 105 cm | Ø 47 1/4" H 41 3/8"
- 4. **Tavolo** | Table | Table | Mesa **Fin.** MI, EO, YC  
L 300 P 100 H 105 cm | W 118 1/8" D 39 3/8" H 41 3/8"
- 5. **Tavolo** | Table | Table | Mesa **Fin.** ML, EN
- 6. **Bench** | Bench | Bench | Bench **Fin.** MI, DC, EO
- 7. **Tavolo** | Table | Table | Mesa **Fin.** MW, EZ, EN  
L 160 P 160 H 105 cm | W 63" D 63" H 41 3/8"



**Piani** | Desk tops | Plateaux | Sobres  
**Spessore 1,8 cm** | 1,8 cm (3/4") thick | 1,8 cm d'épaisseur | 1,8 cm de espesor

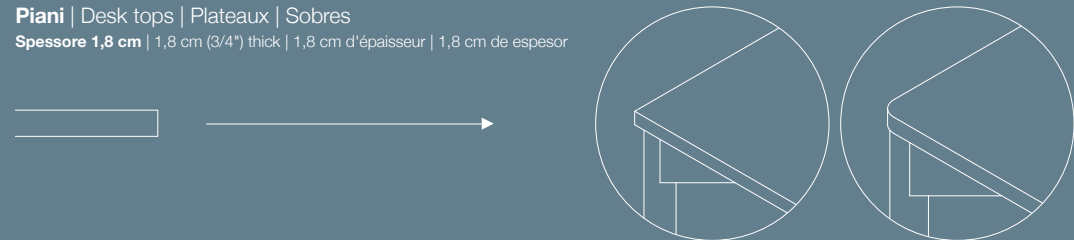

**Struttura** | Structure | Structure | Estructura

**Sezione Ø 3,5 cm** | Section Ø 3,5 cm (1 3/8") | Section Ø 3,5 cm | Sección Ø 3,5 cm

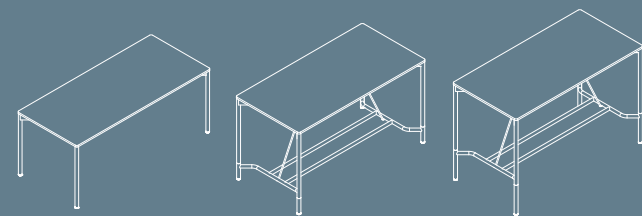

H 73,4 cm  
H 28 7/8"

H 90 cm  
H 35 3/8"

H 105 cm  
H 41 3/8"



**Ruote disponibili per H 73,4 e H 105 cm fino a L 200 cm**  
 Castors available for H 73.4 (28 7/8") and H 105 cm (41 3/8") up to W 200 cm (78 3/4")  
 Roulettes disponibles pour H 73,4 et H 105 cm jusqu'à L 200 cm  
 Ruedas disponibles para H 73,4 y H 105 cm hasta L 200 cm

**Scrivanie/tavoli** | Desks/tables | Bureaux/tables | Mesas

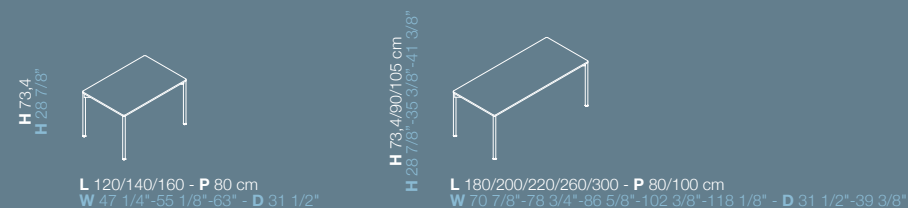

H 73,4 cm  
H 28 7/8"

L 120/140/160 - P 80 cm  
W 47 1/4"-55 1/8"-63" - D 31 1/2"

H 73,4/90/105 cm  
H 28 7/8"-35 3/8"-41 3/8"

L 180/200/220/260/300 - P 80/100 cm  
W 70 7/8"-78 3/4"-86 5/8"-102 3/8"-118 1/8" - D 31 1/2"-39 3/8"

**Bench** | Bench | Bench | Bench

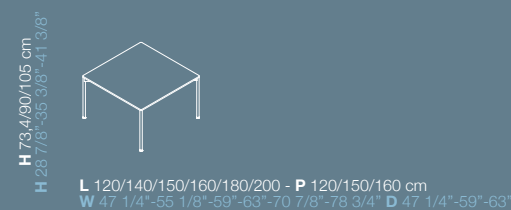

H 73,4/90/105 cm  
H 28 7/8"-35 3/8"-41 3/8"

L 120/140/150/160/180/200 - P 120/150/160 cm  
W 47 1/4"-55 1/8"-59"-63"-70 7/8"-78 3/4" - D 47 1/4"-59"-63"

**Bench/tavoli multipli** | Bench/multiple tables | Bench/tables multiples | Bench/múltiples mesas

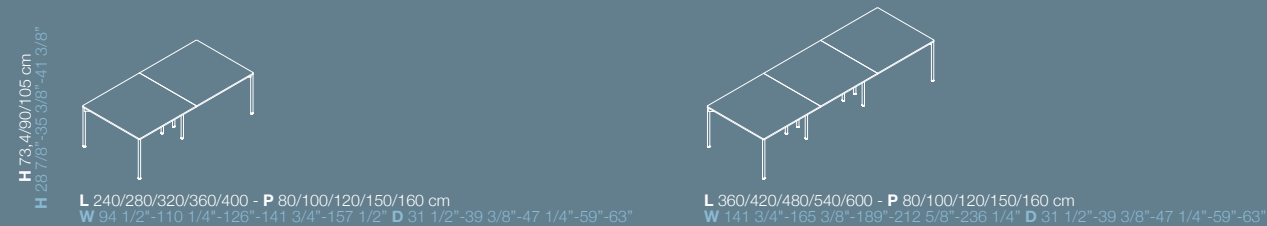

H 73,4/90/105 cm  
H 28 7/8"-35 3/8"-41 3/8"

L 240/280/320/360/400 - P 80/100/120/150/160 cm  
W 94 1/2"-110 1/4"-126"-141 3/4"-157 1/2" - D 31 1/2"-39 3/8"-47 1/4"-59"-63"

L 360/420/480/540/600 - P 80/100/120/150/160 cm  
W 141 3/4"-165 3/8"-189"-212 5/8"-236 1/4" - D 31 1/2"-39 3/8"-47 1/4"-59"-63"

**Tavoli riunione** | Meeting tables | Tables de réunion | Mesas de juntas

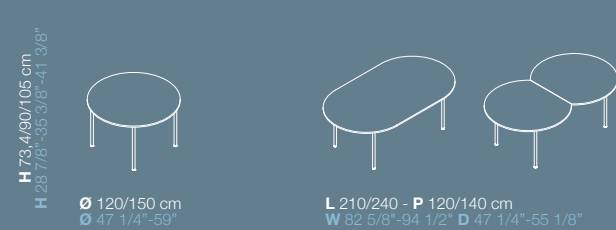

H 73,4/90/105 cm  
H 28 7/8"-35 3/8"-41 3/8"

Ø 120/150 cm  
Ø 47 1/4"-59"

L 210/240 - P 120/140 cm  
W 82 5/8"-94 1/2" - D 47 1/4"-55 1/8"





# Zefiro

**Zefiro è un classico che resiste nel tempo grazie alle sue elevate prestazioni tecniche quali: il telaio perimetrale in alluminio anodizzato con un rapido sistema di aggancio tra gambe e traversi, la particolare sezione della gamba e la tecnologia del magnete per fissare il piano alla struttura.**

**La collezione include anche la possibilità di attrezzare una parete con pannelli in tessuto puntaspilli, pensili con ante scorrevoli in metacrilato, mensole in vetro o contenitori a giorno.**

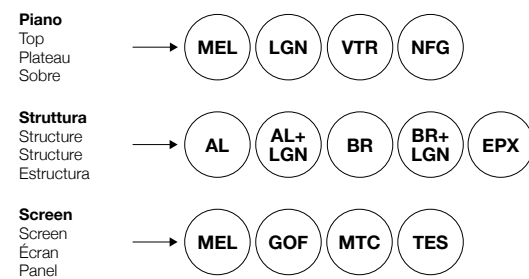

Zefiro thanks to its high technical performance such as: the perimeter frame in anodized aluminium with a quick linking system between legs and crossbars, the special leg section and the magnet technology to secure the top to the structure.

The collection also includes the possibility of adding a supporting wall unit with fabric tackable panels, overheads with acrylic sliding doors, glass shelves or open storage solutions.

Zefiro résiste dans le temps grâce à ses hautes performances techniques telles que: le cadre périphérique en aluminium anodisé avec un système de fixation rapide entre les pieds et les traverses, la section particulière du pied et la technologie de l'aimant pour fixer le plateau sur le cadre de la structure.

La collection comprend également la possibilité d'équiper un panneau mural avec des écrans en tissu punaisable (acoustique), des éléments hauts avec portes coulissantes en méthacrylate, des tablettes en verre ou des rangements avec compartiments ouverts.

Zefiro es un clásico que resiste en el tiempo gracias a sus elevadas características técnicas como: el marco perimetral de aluminio anodizado con un rápido sistema de conexión entre patas y largueros, la particular sección de la pata y la tecnología del imán para fijar el sobre a la estructura.

La colección incluye también la posibilidad de equipar un tabique con paneles en tejido pinchable, contenedores colgantes con puertas corredizas en metacrilato, repisas en vidrio o contenedores colgantes abiertos.

durable  
 clever  
 evergreen





# Zefiro. collection



**Condivisione**  
Sharing  
Partage  
Compartir



**Uffici privati**  
Private offices  
Bureaux privés  
Oficinas privadas



**Workstations**  
Workstations  
Poste de travail  
Estación de trabajo



**Sale riunioni**  
Meeting rooms  
Salles de réunion  
Salas de reuniones

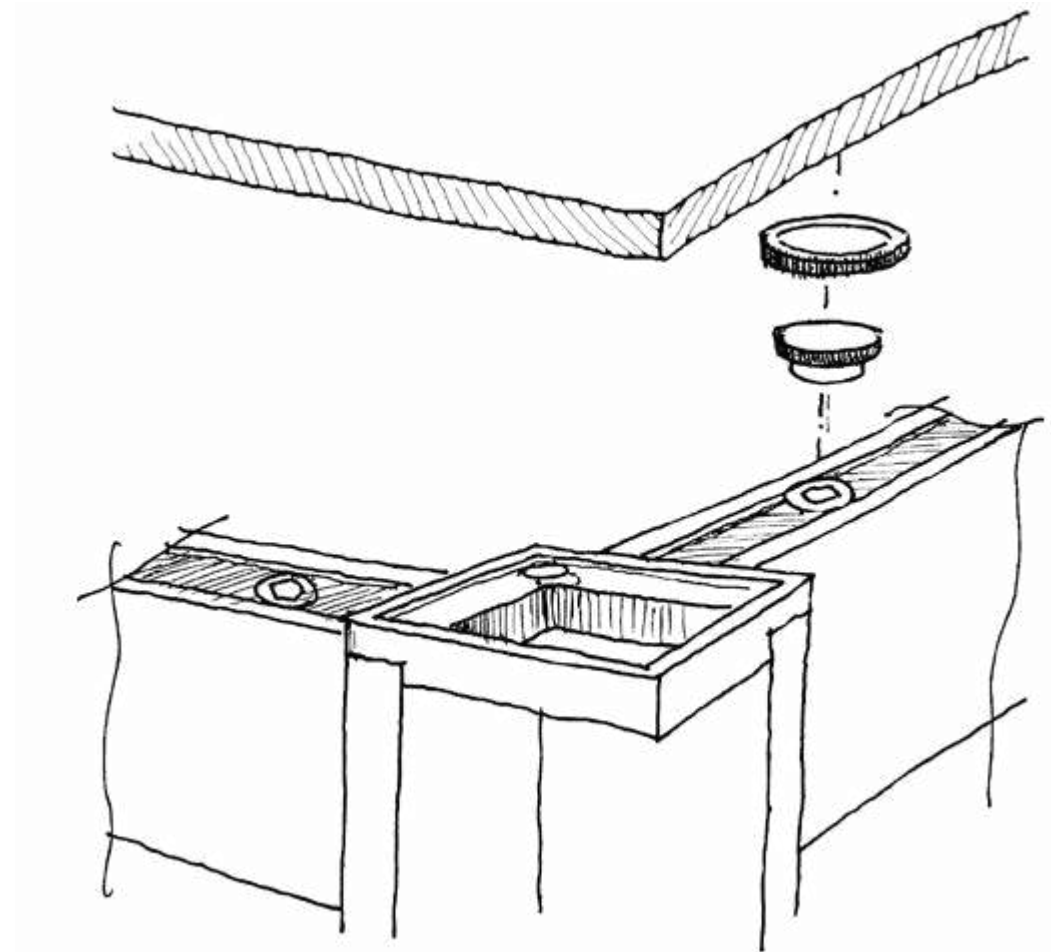





**Piani** | Desk tops | Plateaux | Sobres



**Spessore 1,2 cm**  
1,2 cm thick  
1,2 cm d'épaisseur  
1,2 cm de espesor

**Gambe** | Legs | Pieds | Patas

**Sezione 5,4x5,4 cm** | Section 5,4x5,4 cm (2 1/8"x2 1/8") thick | Section 5,4x5,4 cm | Sección 5,4x5,4 cm

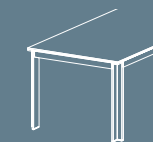

**Sezione a L**  
L section  
Section L  
Sección en L

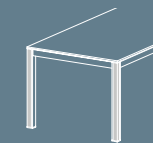

**Sezione a L con inserto in melaminico o legno**  
L section with Italian melamine or wood insert  
Section L avec insert en mélaminé ou bois  
Sección en L con inserto de melaminico o madera

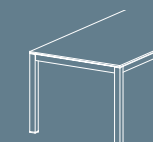

**Sezione quadrata**  
Square section  
Section carrée  
Sección cuadrada

**Scrivanie** | Desks | Bureaux | Mesas

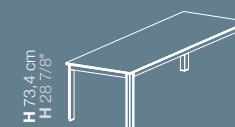

H 73,4 cm  
H 28 7/8"

L 110/130/150/170/190/210 - P 70/90 cm  
W 43 1/4"-51 1/8"-59"-66 7/8"-74 3/4"-82 5/8" - D 27 1/2"-35 3/8"

**Dattilo** | Returns | Retours | Alas



H 73,4 cm  
H 28 7/8"

L 80/100/120 - P 60 cm  
W 31 1/2"-39 3/8"-47 1/4" - D 23 5/8"

**Tavoli riunione** | Meeting tables | Tables de réunion | Mesas de juntas

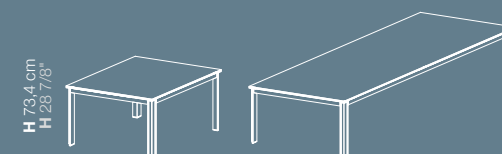

H 73,4 cm  
H 28 7/8"

L/P 90/110 cm W/D 35 3/8"-43 1/4" L 230/270 - P 110 cm W 90 1/2"-106 1/4" - D 43 1/4"

**Mobili di servizio** | Service units | Meuble retour | Muebles de servicio



H 56 cm  
H 22"

L 140/180/190 - P 58 cm W 55 1/8"-70 7/8"-74 3/4" - D 22 7/8" L 160/200/210 - P 58 cm W 63"-78 3/4"-82 5/8" - D 22 7/8"

**Esempi composizioni** | Composition example | Exemples de compositions | Ejemplos de composiciones

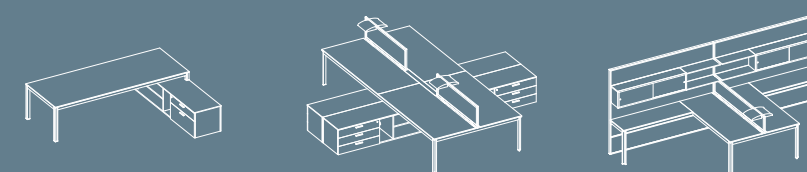

**La collezione Zefiro include paretine a muro modulari, attrezzabili con mensole e corpetti**

Zefiro collection includes modular wall units which can be equipped with shelves and overheads  
La collection Zefiro comprend des panneaux muraux modulables, qui peuvent être équipés d'étagères et de modules-rangement  
La colección Zefiro incluye paneles de pared modulares que se pueden equipar con repisas y contenedores colgantes





**1. Tavolo** | Table | Table | Mesa **Fin.** MW, EZ  
L 270 P 110 cm | W 106 1/4" D 43 1/4"

**2. Tavolo** | Table | Table | Mesa **Fin.** MW, EZ  
L 110 P 110 H 100 cm | W 43 1/4" D 43 1/4" H 39 3/8"

**3. Bench** | Bench | Bench | Bench **Fin.** MI, EO  
L 400 P 180 cm | W 157 1/2" D 70 7/8"



# Blade

**Blade ha un design fortemente distintivo, segnato da linee morbide e avvolgenti, esaltate da combinazioni di colore uniche ed originali.**

**La peculiarità di questa collezione, si esprime nella gamba in metallo tagliata a laser, che si caratterizza per la sua forma a lama: essenziale, forte ed elegante allo stesso tempo.**

**Le scrivanie, danno un tocco originale e ricercato agli ambienti di lavoro.**

**Gli angoli dei piani sono preferibilmente arrotondati per creare un'armonia con il design della gamba.**

**Piano**  
Top  
Plateau  
Sobre



**Struttura**  
Structure  
Structure  
Estructura

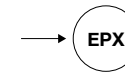

**Screen**  
Screen  
Ecran  
Panel



Blade has a distinctive design, marked by soft lines enhanced by unique and original colour combinations.

The peculiarity of this collection is expressed by the laser-cut metal leg, which appears like a blade: essential, strong and elegant at the same time.

Blade desks give an original and sophisticated touch to work environments.

The corners of the tops are preferably rounded to match the leg design.

Blade a un design distinctif, marqué par lignes douces, enveloppantes, agrémentées de combinaisons de couleurs uniques et originales.

La particularité de cette collection s'exprime dans le pied en métal coupé au laser, qui se caractérise par la forme de sa lame: essentielle, forte et en même temps élégante.

Les coins des plateaux de travail sont arrondis pour créer une harmonie avec le pied.

Les bureaux donnent une touche originale et raffinée aux environnements de travail.

Blade tiene un diseño muy distintivo, marcado por líneas suaves y envolventes, realizadas por combinaciones de color únicas y originales.

La peculiaridad de esta colección se expresa en la pata de metal cortada con láser, que se caracteriza por su forma de hoja: esencial, fuerte y elegante al mismo tiempo.

Los escritorios dan un toque original y refinado al lugar de trabajo.

Las esquinas de las partes superiores se redondean para coincidir con el diseño de la pata.

charismatic  
unique  
contemporary





# Blade. collection



**Uffici privati**  
Private offices  
Bureaux privés  
Oficinas privadas



**Contentori**  
Storage  
Rangements  
Contenedores



**Bench**  
Bench  
Bench  
Bench



**Salè riunioni**  
Meeting rooms  
Salles de réunion  
Salas de reuniones



**Credenze**  
Sideboards  
Buffets  
Aparador  
p. 242 ←

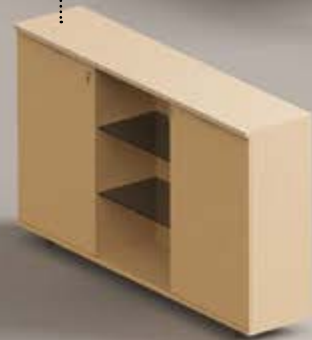

**Tavolini**  
Coffee tables  
Tables basses  
Mesitas



1.



2.





3.





4.

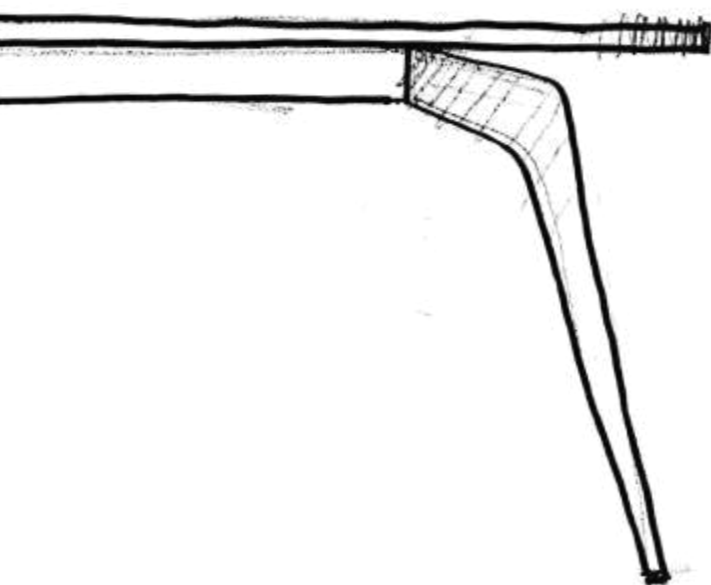

- 1. Bench** | Bench | Bench | Bench **Fin.** MF, EG  
L 200 P 160 cm | W 78 3/4" D 63"  
**Mobile di servizio** | Service unit | Meuble retour | Mueble de servicio  
L 138 P 62 cm | W 54 3/8" D 24 3/8"
- 2. Scrivania** | Desk | Bureau | Mesa **Fin.** MN, EB  
L 180 P 90 cm | W 70 7/8" D 35 3/8"
- 3. Bench** | Bench | Bench | Bench **Fin.** MZ, EE  
L 200 P 160 cm | W 78 3/4" D 63"
- 4. Composizione** | Composition | Composition | Composición  
**Fin.** MN, EB L 400 P 350 cm | W 157 1/2" D 137 3/4"

**Piani** | Desk tops | Plateaux | Sobres  
Spessore 3 cm | 3 cm (1 1/8") thick | 3 cm d'épaisseur | 3 cm de espesor

**Con angoli raggiati**  
With rounded corners  
Avec coins arrondis  
Con esquinas redondeadas

**Gambe** | Legs | Pieds | Patas

**Spessore 1,2 cm**  
1,2 cm thick (1/2")  
1,2 cm d'épaisseur  
1,2 cm de espesor

**Scrivanie** | Desks | Bureaux | Mesas

H 73,4 cm  
H 28 7/8"  
L 120/140/160/180/200 - P 80/90 cm  
W 47 1/4"-55 1/8"-63"-70 7/8"-78 3/4" - D 31 1/2"-35 3/8"

L 120/140/160/180/200 - P 80 cm  
W 47 1/4"-55 1/8"-63"-70 7/8"-78 3/4" - D 31 1/2"

**Dattilo** | Returns | Retours | Alas

H 73,4 cm  
H 28 7/8"  
L 80/100/120 - P 60 cm  
W 31 1/2"-39 3/8"-47 1/4" - D 23 5/8"

**Bench** | Bench | Bench | Bench

H 73,4 cm  
H 28 7/8"  
L 120/140/160/180/200 - P 160 cm  
W 47 1/4"-55 1/8"-63"-70 7/8"-78 3/4" - D 63"

L 240/280/320/360/400 - P 160 cm  
W 94 1/2"-110 1/4"-126"-141 3/4"-157 1/2" - D 63"

L 360/420/480/540/600 - P 160 cm  
W 141 3/4"-165 3/8"-189"-212 5/8"-236 1/4" - D 63"

**Tavoli riunione** | Meeting tables | Tables de réunion | Mesas de juntas

H 73,4 cm  
H 28 7/8"  
Ø 120/150 cm  
Ø 47 1/4"-59"  
L/P 120/160 cm  
W/D 47 1/4"-63"  
L 210/280 - P 120 cm  
W 82 5/8"-110 1/4" - D 47 1/4"

L 420/560 - P 120 cm  
W 165 3/8"-220 1/2" - D 47 1/4"

L 630 - P 120 cm  
W 248" - D 47 1/4"

**Tavolini da caffè** | Coffee tables | Tables basses | Mesitas

H 40 cm  
H 15 3/4"  
L/P 60 cm  
W/D 23 5/8" L 120 - P 60 cm  
W 47 1/4" - D 23 5/8"

**Mobili di servizio** | Service units | Meuble retour | Muebles de servicio

H 63 cm  
H 24 3/4"  
L 138 - P 60 cm  
W 54 3/8" - D 23 5/8" L 207 - P 60 cm  
W 81 1/2" - D 23 5/8"

**Credenze** | Credenzas | Buffets | Muebles

H 88,6 cm  
H 34 7/8"  
L 140/280 - P 45 cm  
W 55 1/8"-110 1/4" - D 17 3/4" L 206 - P 45 cm  
W 81 1/8" - D 17 3/4"

H 127 cm  
H 50"  
L 140/280 - P 45 cm  
W 55 1/8"-110 1/4" - D 17 3/4" L 206 - P 45 cm  
W 81 1/8" - D 17 3/4"



# Crono

**Crono è un sistema di scrivanie e postazioni multiple regolabili elettricamente in altezza. Il sistema è stato studiato e progettato per rispondere alla necessità di creare postazioni di lavoro ergonomiche, capaci di maggiore attenzione alla salute e al benessere dell'utilizzatore.**

**Il sistema Crono è disponibile con elevazione ad 1 o 2 step oltre che nella versione "scrivania singola" o "postazione multipla".**

**L'elevazione è regolata da una pulsantiera che viene fissata sotto il piano, disponibile anche nella versione programmabile con possibilità di memorizzare fino a 4 posizioni in altezza.**

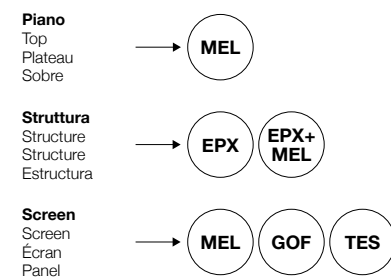

dynamic  
versatile  
adjustable



Crono is an electrical height-adjustable system fitting freestanding desks and benches. The system has been designed to respond to the demand of ergonomic workstations oriented to the health and well-being of the user.

Crono system is available with 1 or 2 step elevation. Moreover it can come as a single freestanding desk or as a multiple workstation bench.

The elevation is controlled by a handswitch positioned underneath the top, also available in the programmable version with the possibility to store up to 4 positions in height.

Crono est un système de bureaux et de bench réglables en hauteur avec commande électronique. Le système a été étudié et conçu pour répondre à la nécessité de créer des postes de travail ergonomiques et de prêter plus d'attention à la santé et au bien-être de l'utilisateur.

Le système Crono est disponible en version 1 ou 2 niveaux ainsi qu'en version "bureau individuel" ou "bench".

L'élévation est contrôlée par un bouton-poussoir sous le plan de travail, également disponible dans la version programmable donnant la possibilité de mémoriser jusqu'à 4 hauteurs différentes.

Crono es un sistema eléctrico de altura ajustable que se adapta a escritorios y bancos independientes. El sistema ha sido diseñado para responder a la demanda de estaciones de trabajo ergonómicas orientadas a la salud y el bienestar del usuario.

El sistema Crono está disponible con elevación de 1 o 2 escalones, así como en la versión de "mesa única" o "estación de trabajo múltiple".

La elevación está controlada por un interruptor de mano ubicado debajo del sobre, también disponible en la versión programable con la posibilidad de almacenar hasta 4 posiciones de altura.





# Crono. collection



**Bench**  
Bench  
Bench  
Bench



**Uffici privati**  
Private offices  
Bureaux privés  
Oficinas privadas





**1. Scrivania** | Desk | Bureau | Mesa **Fin.** MZ, EZ  
L 160 P 80 cm | W 63" D 31 1/2"

**2. Composizione** | Composition | Composition | Composición  
**Fin.** MC, MN, EB L 510 P 170 cm | W 200 3/4" D 66 7/8"

**3. Bench** | Bench | Bench | Bench **Fin.** MZ, EZ  
L 160 P 160 cm | W 63" D 63"

**4. Composizione** | Composition | Composition | Composición  
**Fin.** ME, MN, EN L 290 P 190 cm | W 114 1/8" D 74 3/4"

**5. Composizione** | Composition | Composition | Composición  
**Fin.** ME, MD, EI L 480 P 350 cm | W 189" D 137 3/4"





Piani e strutture | Desk tops and structures | Plateaux et structures | Sobres y estructuras



Pulsantiera | Handswitch | Tableau | Mando de control

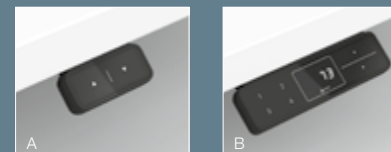

**A) Pulsantiera semplice, B) Pulsantiera con 4 memorie**  
A) Basic handswitch, B) Handswitch with 4 memories  
A) Tableau simple, B) Tableau avec 4 mémoires  
A) Mando de control simple, B) Mando de control con 4 memorias

Piede scrivania freestanding | freestanding desk foot | pied pour bureau individuel | pie para mesa individual

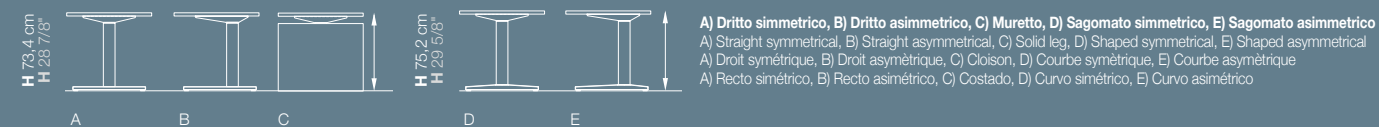

Piede bench | Bench foot | Pied pour bench | Pie para bench

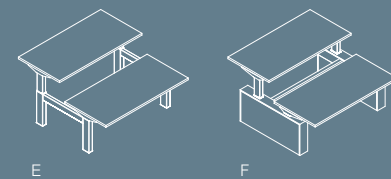

**E) Struttura ad H, F) Struttura con muretto**  
E) H shaped structure, F) Structure with solid leg.  
E) Structure en H, F) Structure avec colonne  
E) Estructura en forma de H, F) Estructura con costado

Scrivanie | Desks | Bureaux | Mesas



L 140/160/180/200 - P 80/90 cm  
W 55 1/8"-63"-70 7/8"-78 3/4" - D 31 1/2"-35 3/8"

Dattilo | Returns | Retours | Alas

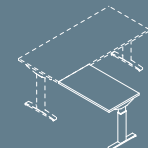

L 80/100/120 - P 60 cm  
W 31 1/2"-39 3/8"-47 1/4" - D 23 5/8"

Esempi composizioni | Composition example | Exemples de compositions | Ejemplos de composiciones

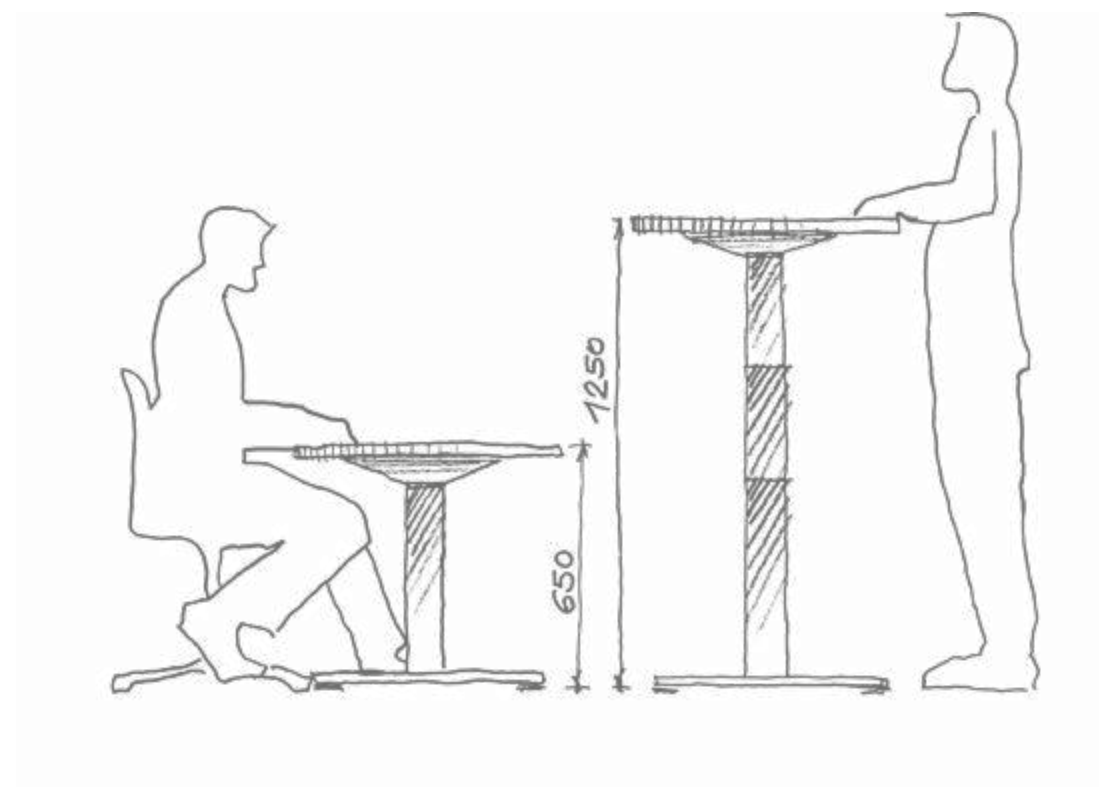
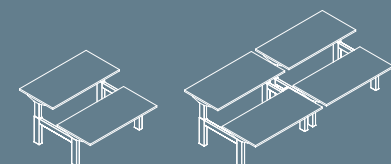

5.





# receptions

Receptions  
Accueils  
Recepciones

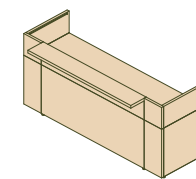

164  
Philo

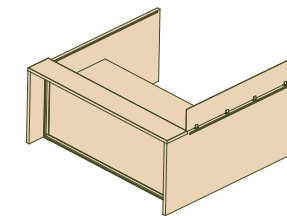

172  
Eos





# Philo

**La reception Philo utilizza pannelli lignei di spessore 40 mm disponibili in diverse finiture melaminiche e in molte colorazioni laccate.**

**La pareti frontali e laterali sono divise in fasce verticali che permettono combinazioni di colore creative. I pannelli laterali sono dotati di profili dove agganciare accessori quali mensole, portacarte e portapenne.**

**Il top reception è disponibile in vetro retrolaccato con profilo in alluminio spazzolato lucido oppure in finitura legno. Può essere collocato in tre diverse posizioni: all'interno, a cavallo o all'esterno della paretina frontale.**

**La reception Philo si abbina a tutte le collezioni Alea.**

Philo reception uses 40 mm (1 5/8") thick wooden panels available in different Italian melamine finishes and in many lacquered colours.

Front and side walls are divided into vertical sections that allow creative colour combinations. The transaction top is available in back-lacquered glass with a polished brushed aluminium profile or in a wood finish.

The side panels come with profiles to attach accessories such as shelves, paper trays and pen holders.

The transaction top can be placed in three different positions: inside, in the middle or outside the front panel.

La banque d'accueil Philo utilise des panneaux en bois d'une épaisseur de 40 mm, disponibles dans différentes finitions mélaminés et dans de nombreuses couleurs laquées.

Les panneaux frontaux et latéraux sont divisés en bandes verticales qui permettent des combinaisons de couleurs. Le support accueil est disponible en verre rétro-laqué avec un profil en aluminium brossé poli ou en finition bois.

Les panneaux latéraux sont équipés de profiles qui permettent de fixer des accessoires tels que des étagères, des porte-cartes et des porte-stylos. Le support accueil peut être positionné en trois positions différentes: à l'intérieur, en position médiane ou à l'extérieur du panneau frontal.

La recepción Philo utiliza paneles de melamina de 40 mm de espesor disponibles en diferentes acabados en melamina y en muchos colores lacados.

Los paneles frontales y laterales se dividen en bandas verticales que permiten combinaciones creativas de colores. La tapa superior está disponible en cristal lacado con perfil de aluminio cepillado, pulido o en acabado de melamina.

Los paneles laterales están equipados con perfiles donde se pueden colocar accesorios como repisas, portapapeles y portapapices. La tapa superior de la recepción se puede colocar en tres posiciones diferentes: en el interior, en el medio o por fuera del panel frontal.

Reception  
Reception  
Accueil  
Recepción



crosswise  
colourful  
playful





# Philo. collection

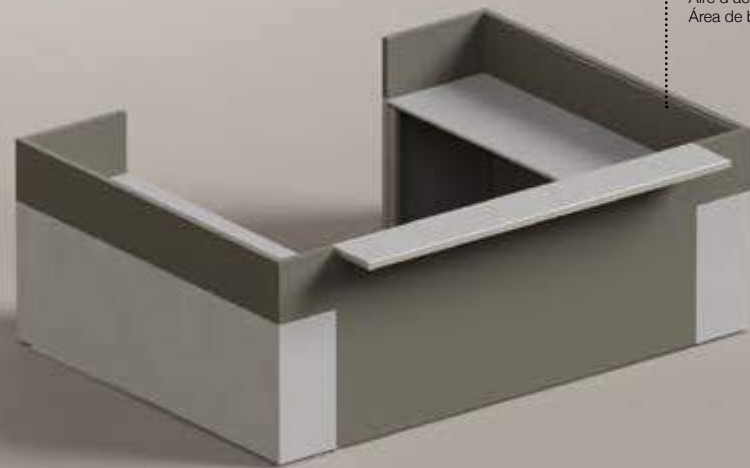

**Area accoglienza**  
Welcome area  
Aire d'accueil  
Área de bienvenida







2.

- 1. Composizione** | Composition | Composition | Composición  
**Fin.** MN, MD, GW, EB **L** 180 x **P** 110 cm | **W** 70 7/8" - **D** 43 1/4"
- 2. Composizione** | Composition | Composition | Composición  
**Fin.** MN, MZ, GW, EZ **L** 260 x **P** 110 cm | **W** 102 3/8" - **D** 43 1/4"
- 3. Composizione** | Composition | Composition | Composición  
**Fin.** MD, MN, MF **L** 200 x **P** 230 cm | **W** 78 3/4" - **D** 90 1/2"



3.



**Mensola** | Top | Support | Estante

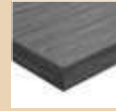

**Senza profilo - melaminico**  
Without profile - Italian melamine  
Sans profil - mélaminé  
Sin perfil - melaminico

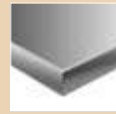

**Con profilo - vetro**  
With profile - glass  
Avec profil - verre  
Con perfil - vidrio

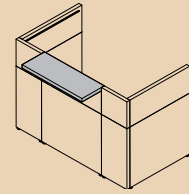

**Montaggio a sbalzo**  
Outward  
Montage en saillie  
Instalación por fuera

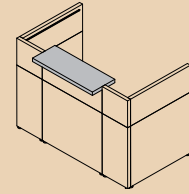

**Montaggio in mezzaria**  
Mid position  
Montage en position médiane  
Instalación en el medio

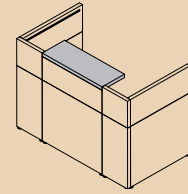

**Montaggio a sbalzo**  
Outward  
Montage en saillie  
Instalación por fuera

**Es. composizioni** | Composition ex. | Ex. de compositions | Ej. de composiciones

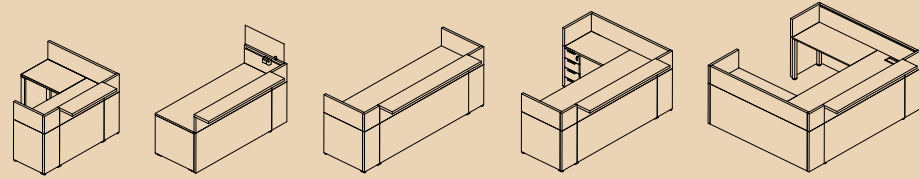



# Eos

**La collezione Eos è in grado di arredare la sala reception grazie all'utilizzo di pochi semplici elementi strutturali: due pannelli laterali, uno frontale (in melaminico, goffrato, tessuto o metacrilato) incorniciato da una struttura in alluminio e un top (lato visitatore) in vetro o legno con profilo in alluminio.**

**Gli elementi che compongono la reception sono modulari e facilmente adattabili. La struttura di Eos è autoportante e indipendente dal tavolo lavoro.**

Eos collection is able to furnish the reception area thanks to few simple structural elements: two side panels, one frontal panel framed by an aluminium structure and one transaction top in glass or wood with an aluminium profile.

The reception components are modular and easily adaptable. Eos structure is freestanding. Any desk can be added within the structure.

La collection Eos est en mesure d'aménager la salle de réception grâce à l'utilisation de quelques éléments structurels simples: deux panneaux latéraux, un panneau frontal avec une structure en aluminium et l'autre en verre ou en bois avec profil en aluminium (côté visiteur).

Les éléments qui composent la banque d'accueil sont modulaires et facilement adaptables. La structure de Eos est autoportante et indépendante du bureau.

La colección Eos es capaz de amueblar la sala de espera gracias a la utilización de unos pocos elementos estructurales: dos paneles laterales, un panel frontal (en melamina, lacado, tejido o metacrilato) enmarcado por una estructura en aluminio y una tapa (lado del visitante) en cristal o melamina con un perfil de aluminio.

Los elementos que componen la recepción son modulares y fácilmente adaptables. La estructura de Eos es autoportante e independiente de la mesa de trabajo.

Reception  
Reception  
Accueil  
Recepción

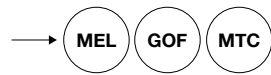

mix'n match  
welcoming  
refined





# Eos. collection



**Area accoglienza**  
Welcome area  
Aire d'accueil  
Área de bienvenida

**1. Composizione** | Composition | Composition | Composición  
**Fin.** MN, MF, GY **L** 210 x **P** 210 cm | **W** 82 5/8" - **D** 82 5/8"

**2. Composizione** | Composition | Composition | Composición  
**Fin.** MN, GW **L** 210 x **P** 100 cm | **W** 82 5/8" - **D** 39 3/8"



1.



**Mensola** | Top | Support | Estante

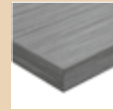

**Senza profilo - melaminico**  
Without profile - Italian melamine  
Sans profil - mélaminé  
Sin perfil - melaminico

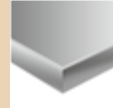

**Con profilo - vetro**  
With profile - glass  
Avec profil - verre  
Con perfil - vidrio

**Pannello frontale** | Frontal panel | Panneau frontal | Panel frontal

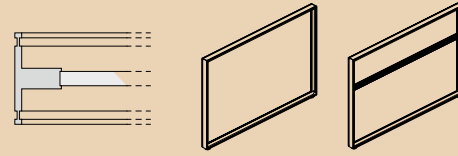

**La parte frontale della reception è caratterizzata da un telaio in alluminio con sezione a "T" e pannelli in melaminico, gofrato, tessuto o metacrilato anche retrolaccato**  
The front of the reception desk features a T section aluminium frame with panels in different finishes: Italian melamine, embossed, fabric or acrylic (also backpainted)  
La partie frontale de la réception est caractérisée par un châssis en aluminium avec section en "T" et panneaux disponibles en mélaminé, gaufré, tissu ou méthacrylate (également rétro-laqué)  
La parte frontal del mueble de recepción está caracterizada por un marco de aluminio de sección en "T" y paneles disponibles en melaminico, lacado, tejido o metacrilato (también lacado por detrás)

**Es. composizioni** | Composition ex. | Ex. de compositions | Ej. de composiciones

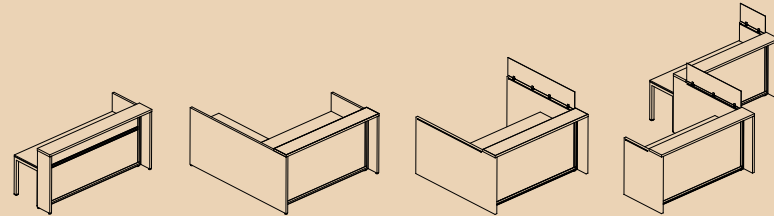



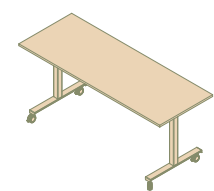

**180**  
**Club**

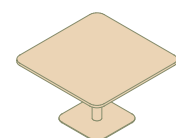

**184**  
**Tavoli**  
Tables  
Tables  
Mesas

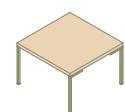

**188**  
**Ciro**

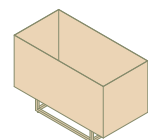

**190**  
**Jungla**

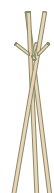

**194**  
**Bamboo**



**198**  
**Ortho**

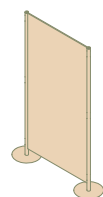

**200**  
**Stream**

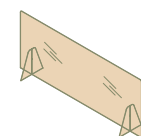

**202**  
**Safe**



# complementi

Complements  
Compléments  
Complementos





# Club

**Il tavolo Club con piano ribaltabile e struttura su ruote, è adatto ad arredare sale polifunzionali ed è dotato di un sistema di aggancio per collegare i tavoli tra loro.**

Club is a folding table on casters with many applications, equipped with ganging device to connect tables side by side.

La table Club avec plateau rabattable et mobile, s'adapte à plusieurs configurations et solutions et convient aux salles polyvalentes. Il est équipé d'un système de fixation pour attacher les tables entre elles.

La mesa Club con el sobre plegable y la estructura sobre ruedas, es adecuada para salas polivalentes. Está equipado con un sistema de unión para vincular las mesas en línea.

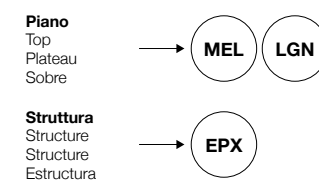

**Condivisione**  
Sharing  
Partage  
Compartir

**Scrivanie** | Desks | Bureaux | Mesas

**Es. composizioni** | Composition ex. | Ex. de compositions | Ej. de composiciones



L 120/140/160/180 - P 60/70/80 cm  
W 47 1/4"-55 1/8"-63"-70 7/8" - D 23 5/8"-27 1/2"-31 1/2"

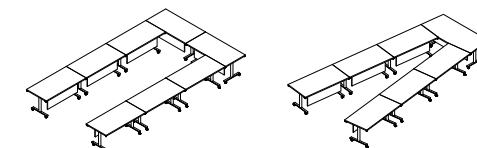



1. **Scrivania** | Desk | Bureau | Mesa **Fin.** MC, EN  
L 140 x P 70 cm | W 55 1/8" - D 27 1/2"

2. **Scrivania** | Desk | Bureau | Mesa **Fin.** MC, ET  
L 160 x P 80 cm | W 63" - D 31 1/2"



2.



# Tavoli

Tables | Tables | Mesas

I tavoli con basamento in metallo, si adattano ad ogni tipo di ambiente. I basamenti sono sia quadrati che circolari, e si abbinano a piani di diverse forme: quadrata, rettangolare, rotonda, a botte.

Tables with metal base, match any type of environment. Bases can be both square and circular, combined with tops of different shapes: square, rectangular, round, barrel shaped.

Les tables à base métallique, s'adaptent à tout type d'environnement. Les bases sont à la fois carrées et rondes, combinées avec des plateaux de différentes formes: carré, rectangulaire, rond, tonneau.

Las mesas con base de metal, son adecuadas para cualquier tipo de ambiente. Las bases son tanto cuadradas como redondas, combinadas con sobres de diferentes formas: cuadradas, rectangulares, redondas, de barril.

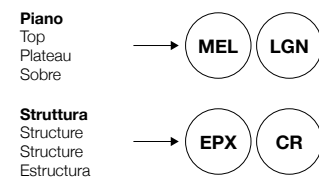

**Sale riunioni**  
Meeting rooms  
Salles de réunion  
Salas de reuniones

Tavoli | Tables | Tables | Mesas

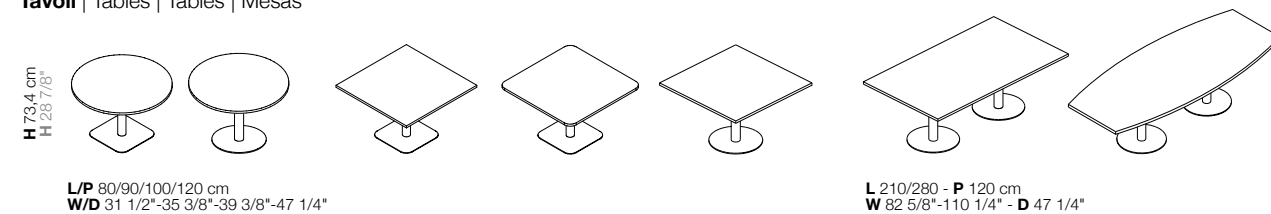





2.



3.

1. **Tavolo** | Table | Table | Mesa **Fin.** ME, EN  
L/P 120 cm | W/D 47 1/4"

2. **Tavolo** | Table | Table | Mesa **Fin.** MN, EB  
Ø 120 cm | Ø 47 1/4"

3. **Tavolo** | Table | Table | Mesa **Fin.** MM, EO  
L 210 P 120 cm | W 82 5/8" D 47 1/4"





# Ciro

**I tavolini da caffè *Ciro*, si possono abbinare facilmente a diverse tipologie di arredo. Le gambe in metallo con forma ad L e sezione quadrata rendono il design di questo complemento particolarmente leggero.**

Ciro coffee tables are meant to be easily paired with different furnishing typology. The metal legs with L shape and square section make this item's design particularly light.

Les tables basses *Ciro*, peuvent être facilement combinées avec différents types de meubles. Les pieds métalliques en forme de L et de section carrée rendent le design de ce complément particulièrement léger.

Las mesitas *Ciro*, pueden ser fácilmente combinadas con diferentes tipos de muebles. Las patas metálicas con forma de L y sección cuadrada hacen que el diseño de este complemento sea particularmente ligero.

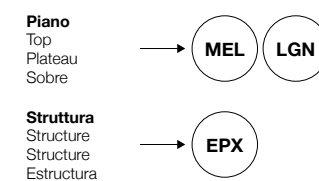

**Tavolini**  
Coffee tables  
Tables basses  
Mesitas

**1. Tavolino da caffè** | coffee table | table basse | mesita  
Fin. NO, EN L/P 60 cm | W/D 23 5/8"

**Tavolini da caffè** | Coffee tables | Tables basses | Mesitas

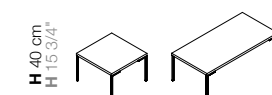

L 60/120 - P 60 cm  
W 23 5/8"-47 1/4" - D 23 5/8"

1.



# Jungla

**Jungla è il porta piante completamente realizzato in metallo, disponibile in vari colori epossidici. Si tratta di un sistema di vasi sorretti da un basamento che li eleva dal pavimento, arrivando a creare dei veri e propri divisori verdi. Viene proposto nelle versioni con uno o tre vasi.**

Jungla is the planter completely made of metal, available in various epoxy colours. It is a system of pots supported by a base that elevates them from the floor, creating true green dividers. It is available in versions with one or three pots.

Jungla est le porte-plante entièrement en métal, disponible en différentes couleurs époxy. C'est un système de vases soutenus par une base qui les surélève du sol, créant de véritables cloisons vertes. Il est proposé en versions à un ou trois pots.

Jungla es la jardinera completamente de metal, disponible en varios colores epoxi. Se trata de un sistema de macetas apoyadas en una base que las eleva del suelo, creando verdaderos separadores verdes. Está disponible en versiones con una o tres macetas.

Struttura  
Structure  
Structure  
Estructura



Porta piante | Planters | Porte-plante | Jardineras

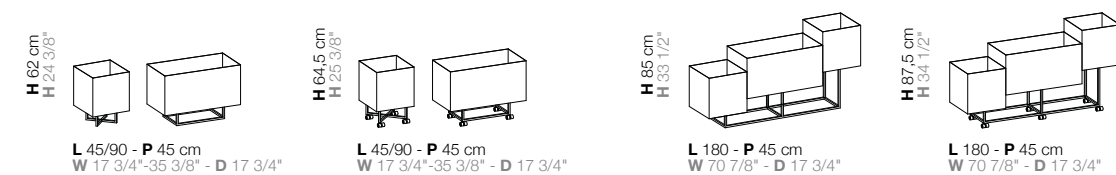





2.

**1. Porta piante** | Planters | Porte-plante | Jardineras **Fin. EE**  
 L 90 cm | W 35 3/8"

**2. Porta piante** | Planters | Porte-plante | Jardineras **Fin. TR**  
 L 180 cm | W 70 7/8"

**3. Porta piante** | Planters | Porte-plante | Jardineras **Fin. TR**  
 L 45 cm | W 17 3/4"



3.





# Bamboo

**Bamboo è l'appendiabiti freestanding semplice e contemporaneo. Bamboo è composto da tubolari in metallo disposti ad intreccio e verniciati a polveri epossidiche, disponibili in tutti i colori della palette Alea. I pochi elementi che lo compongono creano svariati punti di appiglio per giacche e cappotti. L'altezza complessiva è di 170 cm.**

Bamboo is the simple and contemporary freestanding coat rack. Bamboo is made up of metal tubes arranged in an interlocking pattern and painted with epoxy powders, available in the whole Alea colour palette. The few elements that compose it create a variety of holding points for jackets and coats. Its total height is 170 cm (66 7/8").

Bamboo est un porte-manteau autoportant simple et contemporain. Bamboo est constitué de tubes métalliques entrelacés et peints avec des poudres époxy, disponibles dans toutes les couleurs de la palette Alea. Les quelques éléments qui le composent créent une variété de points de maintien pour les vestes et les manteaux. La hauteur totale est de 170 cm.

Bamboo es el perchero independiente sencillo y contemporáneo. Bamboo se compone de tubos metálicos entrelazados y pintados con polvos epoxídicos, disponibles en todos los colores de la paleta Alea. Los pocos elementos que la componen crean una variedad de puntos de sujeción para chaquetas y abrigos. La altura total es de 170 cm.

Struttura  
Structure  
Structure  
Estructura



**Appendiabiti** | Coat rack | Porte-manteau | Perchero



H 170 cm  
H 66 7/8"

L 43 - P 43 cm  
W 16 7/8" - D 16 7/8"





2.

1. **Appendiabiti** | Coat rack | Porte-manteau | Perchero **Fin.** EO

2. **Appendiabiti** | Coat rack | Porte-manteau | Perchero **Fin.** EI

3. **Appendiabiti** | Coat rack | Porte-manteau | Perchero **Fin.** YC



3.



# Ortho

## .paretina

**Le paretine Ortho sono pensate per essere agganciate alle scrivanie, ottenendo così un angolo di privacy in modo facile e veloce. La paretina è composta da un pannello in melaminico di spessore 30 mm e con angoli raggati, disponibile anche con rivestimento tessuto, e da un piede in metallo verniciato epossidico che la sostiene.**

Ortho wall panels are designed to be attached to desks, thus obtaining a corner of privacy quickly and easily. The panel is composed of a 30 mm (1 1/8") thick melamine panel with rounded corners, also available with fabric cover, and an epoxy painted metal foot that supports it.

Les cloisons Ortho sont conçues pour être fixées aux bureaux, ce qui permet d'obtenir un coin d'intimité rapidement et facilement. Elle est composée d'un panneau en mélamine de 30 mm d'épaisseur avec coins arrondis, également disponible revêtue en tissu et par un pied en métal époxy.

Los biombos divisorios de Ortho están diseñados para ser fijados a los escritorios, obteniendo así un rincón de privacidad de forma rápida y fácil. El panel está compuesto por un panel de melamina de 30 mm de grosor con esquinas redondeadas, también disponible con cubierta de tela, y un pie metálico pintado con epoxy que lo sostiene.

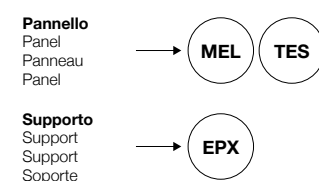

**1. Paretina** | Wall panel | Cloison | Biombo **Fin. DC, ET**  
L 80 cm | W 31 1/2"

**Paretina** | Wall panel | Cloison | Biombo

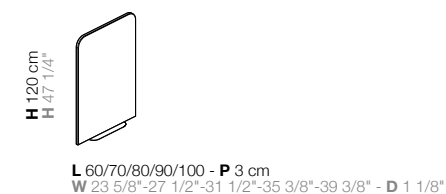

1.





# Stream

**Stream è un sistema indipendente composto da un pannello supportato da una coppia di tubolari metallici con basamenti. I pannelli sono disponibili in diversi materiali e finiture per adattarsi a qualsiasi tipo di stile ed utilizzo. Possono inoltre essere agganciati in diverse posizioni per creare un layout dinamico.**

Stream is a freestanding panel system supported by a pair of metal poles with a round base. Panels are available in different materials and finishes to adapt to any type of use and style. Panels can be hung in several positions in order to create a dynamic layout.

Stream est un système de panneaux autoportants soutenu par une paire de poteaux métalliques avec bases rondes. Les panneaux sont disponibles en différents matériaux et finitions pour s'adapter à tout type d'utilisation et de style. Les panneaux peuvent être suspendus dans plusieurs positions afin de créer une disposition dynamique.

Stream es un sistema de panel independiente soportado por un par de tubulares metálicos con bases redondas. Los paneles están disponibles en diferentes materiales y acabados para adaptarse a cualquier tipo de uso y estilo. Los paneles se pueden ser enganchados en varias posiciones para crear un diseño dinámico.

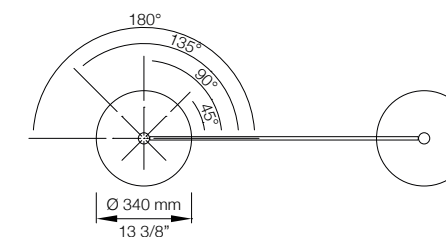
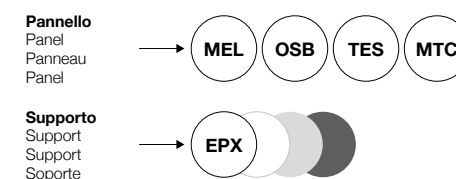

**1. Paretina** | Wall panel | Cloison | Biombo **Fin.** BN, EB  
**H** 178 cm | **H** 70"

**Paretina** | Wall panel | Cloison | Biombo

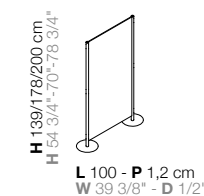



# Safe

**Safe, è la linea di prodotti che trasforma l'ambiente in un luogo sicuro e sano. Gli screen Safe sono progettati per proteggere le persone da virus e batteri. Rispondono alle regolamentazioni attualmente in vigore e sono molto facili da pulire ed installare. Alea propone diverse soluzioni.**

Safe, is the product line that transforms the environment into a safe and healthy place. Safe screens are designed to protect people from viruses and bacteria. They comply with current regulations and are very easy to clean and install. Alea offers different solutions.

Safe, est la ligne de produits qui transforme l'environnement de travail dans un lieu sûr et sain. Les écrans Safe sont conçus pour protéger les gens contre les virus et bactéries. Ils sont conformes à la réglementation en vigueur et sont très simple à nettoyer et à installer. Alea propose différentes solutions.

Safe, es la línea de productos que transforma el medio ambiente en un lugar seguro y saludable. Las pantallas Safe están diseñadas para protegerlo de virus y bacterias. Cumplen a las regulaciones globales y son fáciles de limpiar e instalar. Alea propone varias soluciones.

- Pannello**  
Panel  
Panneau  
Panel
- **MTC**
- Supporto**  
Support  
Support  
Soporte
- **MTC** **EPX**

- Divisori**  
Dividers  
Séparateurs  
Separadores



**1) Base in metacrilato, 2) Base in metallo, 3) Staffa in metallo, 4) Morsetto in metallo**  
1) Methacrylate base, 2) Metal base, 3) Metal bracket, 4) Metal clamp  
1) Base en méthacrylate, 2) Base métallique, 3) Support métallique, 4) Pince métallique  
1) Base de metacrilato, 2) Base metálica, 3) Soporte metálico, 4) Abrazadera metálica

## Paretina | Wall panel | Cloison | Biombo

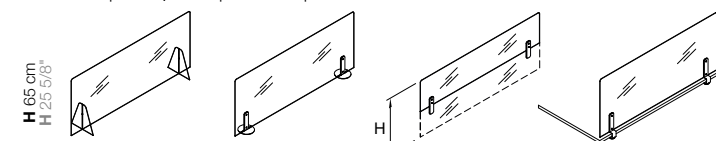

L 60/80/90/100/120/140/160/180/200 cm  
W 23 5/8"-31 1/2"-35 3/8"-39 3/8"-47 1/4"-55 1/8"-63"-70 7/8"-78 3/4"







# librerie

Bookcases  
Bibliothèques  
Libreros

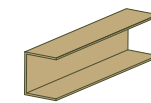

**206**  
Icaro

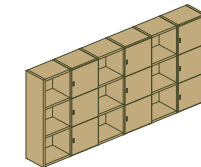

**208**  
Titano

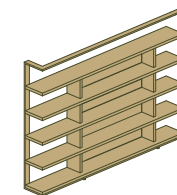

**212**  
Archimede

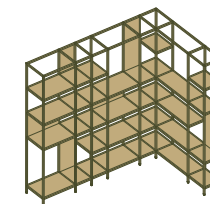

**216**  
Q18



# Icaro

**Le mensole modulari Icaro sono realizzate in lamiera di acciaio piegata e verniciata a polveri epossidiche. Vengono fissate al muro tramite supporti a scomparsa e possono essere dotate di fermalibri verticali in metallo che si possono spostare lungo la mensola.**

Icaro modular shelves are made of folded steel sheet epoxy painted. They are fixed to the wall by means of concealed brackets and can be equipped with vertical metal bookends that can be moved along the shelf.

Les étagères modulaires Icaro sont réalisées en tôle d'acier pliée, vernis à poudre époxy et se fixent au mur parmi de supports invisibles. Il est possible d'intégrer les étagères avec de ferme-livres mobiles en métal qui peuvent être déplacés à discrétion le long de l'étagère.

Las estanterías modulares Icaro están realizadas en chapa de acero plegada y pintada con pintura epoxi. Se fijan a la pared mediante soportes retráctiles y se pueden equipar con separadores verticales metálicos para libros que se pueden desplazar a lo largo de la estantería.

Mensola  
Shelves  
Étagères  
Librero

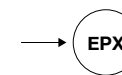

**1. Mensola** | Shelf | Étagère | Estantería **Fin. EO**  
L 150 cm | W 59"



**Librerie**  
Bookcases  
Bibliothèques  
Libreros

**Mensola** | Shelf | Étagère | Estantería

H 36,7 cm  
H 14 1/2"

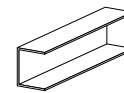

L 50/100/150/200 - P 27,5 cm  
W 19 3/4"-39 3/8"-59"-78 3/4" - D 10 7/8"

1.



# Titano

**Le librerie modulari Titano prevedono un'articolata componibilità sia verticale che orizzontale. Ai vani a giorno è possibile applicare delle ante quadrate con maniglia incassata oppure dei contenitori classificatori.**

Titano modular bookshelf provides a wide range of vertical and horizontal solutions. Square doors or filing cabinets with recessed handles can be integrated to the bookshelf.

Les bibliothèques modulaires Titano offrent une modularité articulée soit verticalement que horizontalement. Pour les compartiments ouverts, il est possible d'appliquer des portes carrées avec des poignées intégrées ou des bloc de 2 tiroirs pour dossiers suspendus.

Los libreros modulares Titano presentan una modularidad articulada tanto vertical como horizontal. En los módulos abiertos se pueden aplicar las siguientes puertas cuadradas con tirador embutido o contenedores archivadores.

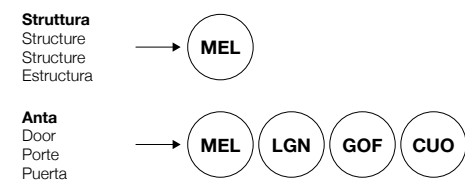

**Librerie**  
Bookcases  
Bibliothèques  
Libreros

**Moduli** | Modules | Modules | Módulos

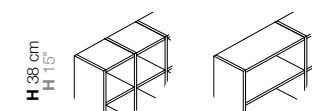

**H 38 cm**  
**H 15"**

**Dimensioni vano utile**  
Internal dimensions  
Dimensions utiles du module  
Dimensiones útiles del módulo

**L 38/79 - P 39,4 cm**  
**W 15"-31 1/8" - D 15 1/2"**

**Esempi librerie** | Example bookshelves | Exemples bibliothèque | Ejemplos libreros

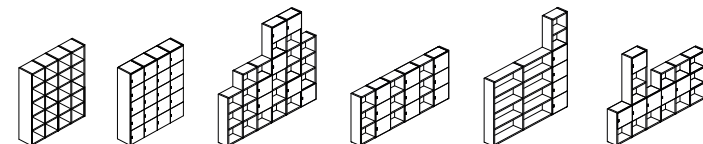

1.





2.



4.



3.

1. **Libreria** | Bookshelf | Bibliothèque | Librero **Fin.** MZ, MI

2. **Libreria** | Bookshelf | Bibliothèque | Librero **Fin.** MN  
L 330 P 39 H 210 cm | W 129 7/8" D 15 3/8" H 82 5/8"

3. **Libreria** | Bookshelf | Bibliothèque | Librero **Fin.** MN, ME  
L 495 P 43 H 127 cm | W 194 7/8" D 16 7/8" H 50"

4. **Libreria** | Bookshelf | Bibliothèque | Librero **Fin.** MN, MD  
L 250 cm P 43 H 127 cm | W 98 3/8" D 16 7/8" H 50"



# Archimede

**La libreria Archimede si contraddistingue per il suo design lineare composto da una struttura in metallo che va ad incorniciare le mensole. Disponibile anche nella versione con vano TV.**

The Archimede bookcase stands out for its linear design composed of a metal structure that frames the shelves. Also available with a TV compartment.

La bibliothèque Archimede se distingue par son design linéaire composé d'une structure en métal qui encadre les étagères. En outre disponible dans la version avec compartiment de télévision.

El librero Archimede se distingue por su diseño lineal compuesto por una estructura metálica que enmarca las repisas. También disponible en la versión con compartimento para TV.

**Struttura**  
Structure  
Structure  
Estructura



EPX

**Mensole**  
Shelves  
Étagères  
Libreros



MEL

GOF



**Librerie**  
Bookcases  
Bibliothèques  
Libreros

**Librerie** | Bookshelves | Bibliothèque | Libreros

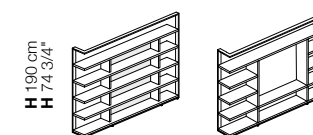

H 190 cm  
H 74 3/4"

L 272 - P 36 cm  
W 107 1/8" - D 14 1/8"



1. **Libreria** | Bookshelf | Bibliothèque | Libro **Fin.** MM, MJ, EI

2. **Libreria** | Bookshelf | Bibliothèque | Libro **Fin.** MF, MC, ES





# Q18

**Il design unico del sistema di librerie Q18, è l'equilibrio perfetto tra coplanarità dei componenti, libertà di layout e molteplici opzioni di colore. Q18 è una soluzione modulare composta da una struttura in tubolare di alluminio con sezione 18x18 mm, alla quale vengono integrati pannelli e moduli contenitori. Il sistema di fissaggio intelligente che unisce le parti in alluminio rende questo prodotto elegante e pulito, senza viti a vista.**

The unique design of the Q18 shelving system is the perfect balance between flushness of components, layout freedom and multiple colour options. Q18 is a modular solution consisting of a tubular aluminium structure with 18x18 mm (3/4"x3/4") section, to which panels and container modules are integrated. The intelligent fixing system that combines the aluminium parts makes this product elegant and clean, without visible screws.

Le design unique du système d'étagères Q18 est l'équilibre parfait entre la fluidité des composants, la liberté d'agencement et les multiples options de couleurs. Q18 est une solution modulaire constituée d'une structure tubulaire en aluminium de section 18x18 mm, à laquelle sont intégrés des panneaux et des modules de conteneurs. Le système de fixation intelligent qui combine les pièces en aluminium rend ce produit élégant et propre, sans vis apparentes.

El diseño único de la estantería Q18 es el equilibrio perfecto entre la coplanaridad de los componentes, la libertad de distribución y las múltiples opciones de color. Q18 es una solución modular que consiste en una estructura tubular de aluminio de sección 18x18 mm, a la que se integran paneles y módulos de contenedores. El sistema de fijación inteligente que combina las piezas de aluminio hace que este producto sea elegante y limpio, sin tornillos visibles.

**Struttura**  
Structure  
Structure  
Estructura

→ **EPX**

**Pannelli**  
Panels  
Panneaux  
Paneles

→ **MEL**



**Librerie**  
Bookcases  
Bibliothèques  
Libreros



**Workstations**  
Workstations  
Poste de travail  
Estación de trabajo



**Condivisione**  
Sharing  
Partage  
Compartir



**Tavolini**  
Coffee tables  
Tables basses  
Mesitas

**Es. composizioni** | Composition ex. | Ex. de compositions | Ej. de composiciones

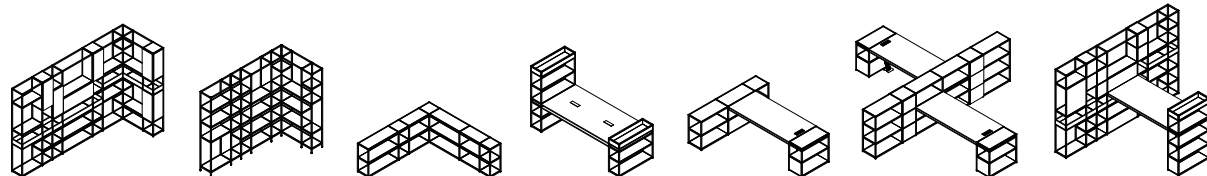





2.



4.

1. **Libreria** | Bookshelf | Bibliothèque | Librero **Fin.** MK, EI  
**L** 262 **P** 46 **H** 215 cm | **W** 103 1/8" **D** 18 1/8" **H** 84 5/8"

2. **Libreria** | Bookshelf | Bibliothèque | Librero **Fin.** MK, MJ, MT, EN  
**L** 292 **P** 46 **H** 180 cm | **W** 115" **D** 18 1/8" **H** 70 7/8"

3. **Libreria** | Bookshelf | Bibliothèque | Librero **Fin.** MT, ET  
**L** 162 **P** 33 **H** 77 cm | **W** 63 3/4" **D** 13" **H** 30 1/4"  
**Tavolini** | Coffee tables | Tables basses | Mesitas  
**L** 60 **P** 60 **H** 41 cm | **W** 23 5/8" **D** 23 5/8" **H** 16 1/8"

4. **Libreria** | Bookshelf | Bibliothèque | Librero **Fin.** MC, ML, EN  
**L** 400 **P** 46 **H** 215 cm | **W** 157 1/2" **D** 18 1/8" **H** 84 5/8"

5. **Libreria** | Bookshelf | Bibliothèque | Librero **Fin.** MK, MJ, EN  
**L** 232 **P** 33 **H** 300 cm | **W** 91 3/8" **D** 13" **H** 118 1/8"







222

**Cassettiere**

Pedestals  
Blocs tiroirs  
Cajoneras

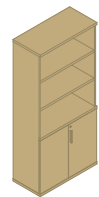

226

**Remo**



230

**Ottanta/  
Novanta**

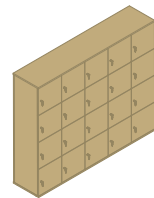

234

**Lato**

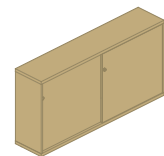

238

**Romolo**

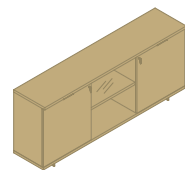

242

**Blade X**

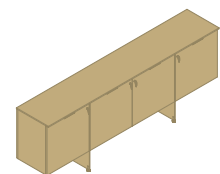

246

**Oasi**

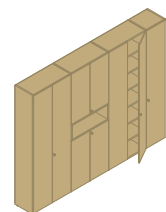

250

**Quattro**



# contenitori

Storage  
Rangements  
Contenedores





# Cassettiere

Pedestals | Blocs tiroirs | Cajoneras

**Le cassettiere su ruote si adattano ad ogni collezione Alea e possono avere maniglie o presa laterale. Sono inoltre disponibili mobili di servizio con cassetti, vani a giorno o ante, sorretti da ruote.**

Pedestals on wheels are complementary to every Alea collection and may have handles or side grip. Service units on wheels with drawers, open compartments or doors are also available.

Les blocs tiroirs sur roulettes s'adaptent à toutes les collections Alea et peuvent être dotés des poignées ou disposer d'une prise latérale. Des meubles de service avec tiroirs, compartiments ouverts ou portes sont également disponibles, supportées par des roulettes.

Las cajoneras con ruedas son adaptables a todas las colecciones Alea y pueden tener tiradores o empuñaduras laterales. También están disponibles muebles de servicio con cajones, compartimentos abiertos o puertas, soportados por ruedas.

**Cassettiere**  
Pedestals  
Blocs tiroirs  
Cajoneras



**Contentori**  
Storage  
Rangements  
Contenedores

**Cassettiere** | Drawer units | Blocs tiroirs | Cajoneras

**Mobili di servizio** | Service units | Meubles de service | Muebles de servicio

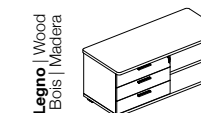
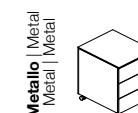





2.



3.

**1. Cassetiere** | Drawer units | Blocs tiroirs | Cajoneras  
**Fin.** MD L 33 P 58 H 55 cm | **W** 13" **D** 22 7/8" **H** 21 5/8"

**2. Cassetiere** | Drawer units | Blocs tiroirs | Cajoneras  
**Fin.** EB L 42 P 53 H 55 cm | **W** 16 1/2" **D** 20 7/8" **H** 21 5/8"

**3. Cassetiere** | Drawer units | Blocs tiroirs | Cajoneras  
**Fin.** ME L 45 P 58 H 55 cm | **W** 17 3/4" **D** 22 7/8" **H** 21 5/8"



# Remo

**Remo è un sistema di contenitori modulari e sovrapponibili con ante battenti e vani a giorno. L'intera scocca è composta da pannelli da 18 mm, mentre top e fondo sono spessi 30 mm.**

Remo is a storage system made of modular and stackable units, with hinged doors or open shelving. The entire case is made of 18 mm (3/4") thick panels, while top and bottom are 30 mm (1 1/8") thick.

**Ante** | Doors | Portes | Puertas

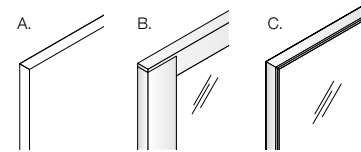

**A. Senza profilo, B. Con profilo sp 50 mm, C. Con profilo 5 mm**  
 A. Without profile, B. With 50 mm (2") profile, C. With 5 mm (1/4") profile  
 A. Sans profil, B. Avec profil ép. de 50 mm, C. Avec profil ép. de 5 mm  
 A. Sin perfil, B. Con perfil esp. 50 mm, C. Con perfil esp. 5 mm

Remo est un système de armoires modulaires et empilables avec portes battantes et compartiments ouverts. Le corps entier est composé de panneaux de 18 mm, tandis que le haut et le bas ont une épaisseur de 30 mm.

Remo es un sistema de contenedores modulares y apilables con puertas abatibles y compartimentos abiertos. El cuerpo entero está compuesto de paneles de 18 mm, mientras que el top superior y el suelo tienen un grosor de 30 mm.

- Scocca**  
Body  
Corps  
Cuerpo → MEL
- Ante**  
Panels  
Panneaux  
Paneles → MEL MTC GOF
- Ripiani**  
Shelves  
Tablettes  
Estantes → MEL EPX



**Contenitori**  
Storage  
Rangements  
Contenedores

**Contenitori** | Storage | Armoires | Armarios

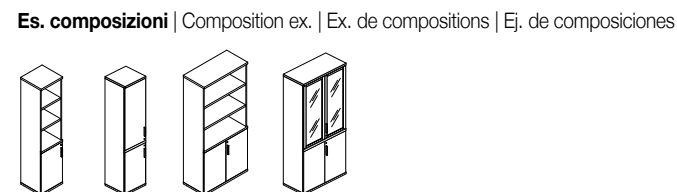
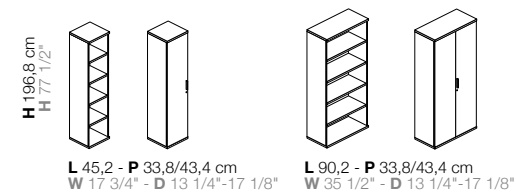
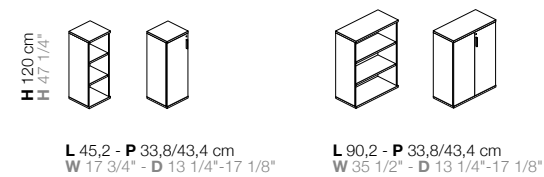
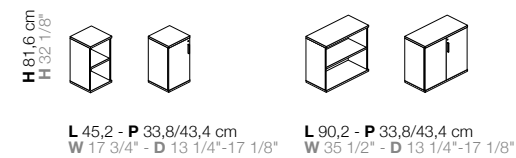





**1. Contenitore** | Storage | Rangement | Contenedor  
**Fin.** MD, MN **L** 90 **P** 43 **H** 81 cm | **W** 35 3/8" **D** 16 7/8" **H** 31 7/8"  
 Porta piante | Planter | Cache-pot | Jardinera  
**H** 21 cm | **H** 8 1/4"

**2. Contenitore** | Storage | Rangement | Contenedor  
**Fin.** MN, MC **L** 270 **P** 43 **H** 81 cm | **W** 106 1/4" **D** 16 7/8" **H** 31 7/8"

**3. Contenitore** | Storage | Rangement | Contenedor  
**Fin.** MF, MN **L** 180 **P** 43 **H** 197 cm | **W** 70 7/8" **D** 16 7/8" **H** 77 1/2"





# Ottanta/ Novanta

**Ottanta e Novanta sono contenitori con ante battenti che differiscono tra loro per modularità: Ottanta ha larghezza 40 e 80 cm mentre Novanta ha larghezza 45 e 90 cm. I moduli sono sovrapponibili.**

Ottanta and Novanta are storage systems with hinged doors that differ in modularity: Ottanta has 40 and 80 cm (15 3/4" and 31 1/2") width while Novanta has 45 and 90 cm (17 3/4" and 35 3/8") width. Modules can be stacked.

**Ante** | Doors | Portes | Puertas

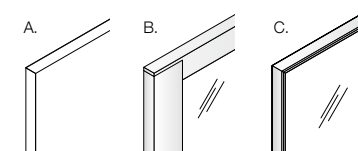

**A. Senza profilo, B. Con profilo sp 50 mm, C. Con profilo 5 mm**  
 A. Without profile, B. With 50 mm (2") profile, C. With 5 mm (1/4") profile  
 A. Sans profil, B. Avec profil ép. de 50 mm, C. Avec profil ép. de 5 mm  
 A. Sin perfil, B. Con perfil esp. 50 mm, C. Con perfil esp. 5 mm

Ottanta et Novanta sont des armoires à portes battantes de modularité différente: Ottanta a 40 et 80 cm de largeur tandis que Novanta a une largeur de 45 et 90 cm. Les modules peuvent être empilés.

Ottanta y Novanta son contenedores con puertas abatibles que difieren entre sí para la modularidad: Ottanta tiene un ancho de 40 y 80 cm mientras que Novanta tiene un ancho de 45 y 90 cm. Los módulos son apilables.

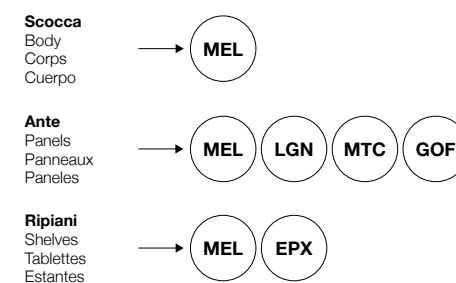

**Contenitori**  
Storage  
Rangements  
Contenedores

**Contenitori** | Storage | Armoires | Armarios

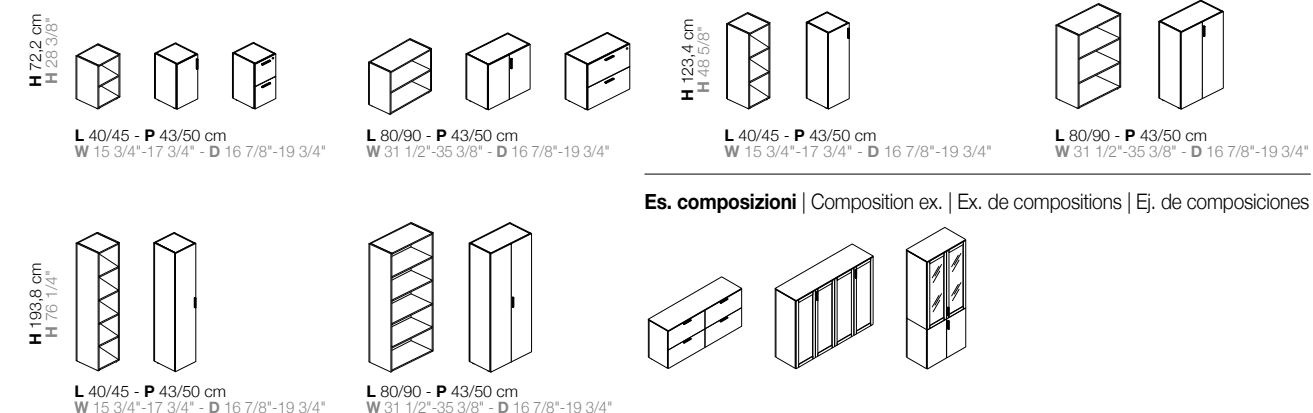





2.

**1. Contenitore** | Storage | Rangement | Contenedor  
**Fin.** MK, MI, BN **L** 320 **P** 43 **H** 123 cm | **W** 126" **D** 16 7/8" **H** 48 3/8"

**2. Contenitore** | Storage | Rangement | Contenedor  
**Fin.** MO, BN **L** 180 **P** 43 **H** 194 cm | **W** 70 7/8" **D** 16 7/8" **H** 76 3/8"

**3. Contenitore** | Storage | Rangement | Contenedor  
**Fin.** MI, MK **L** 90 **P** 43 **H** 72 cm | **W** 35 3/8" **D** 16 7/8" **H** 28 3/8"  
 Porta piante | Planter | Cache-pot | Jardinera  
**H** 21 cm | **H** 8 1/4"



3.



# Lato .locker

Lato è un sistema di armadietti con scocca in melaminico disponibile in svariate combinazioni. I suoi moduli sono adatti ad archiviare documenti oppure effetti personali in contesti quali uffici, palestre, spogliatoi.

Lato is a modular locker system. Lato's modules can be used to store documents or personal belongings in offices, gyms or dressing rooms.

Lato est un système d'armoires avec structure en mélaminé disponible dans différentes combinaisons. Ses modules sont indiqués pour archiver documents ou effets personnels dans des contextes tels que bureaux, gymnases et vestiaires.

Lato es un sistema de casilleros con estructura en melaminico disponible en varios colores. Sus módulos se pueden usar para almacenar documentos o efectos personales en contextos como oficinas, gimnasios, vestuarios.

## Serrature | Locking systems | Serrures | Cerraduras

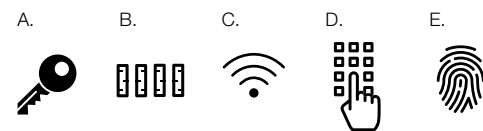

**A. Chiave cifrata, B. Combinazione meccanica, C. RFID, D. Combinazione elettronica, E. Impronta digitale**  
 A. Warded key, B. Mechanical combination, C. RFID, D. Electronic combination, E. Fingerprint  
 A. Clé chiffrée, B. Combinaison mécanique, C. RFID, D. Combinaison électronique, E. Empreinte digitale  
 A. llave cifrada, B. Combinación mecánica, C. RFID, D. Combinación electrónica, E. Huellas dactilares



**Contenitori**  
 Storage  
 Rangements  
 Contenedores

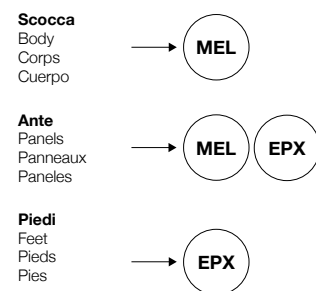

## Moduli | Modules | Modules | Módulos

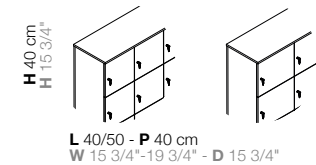

## Esempi | Examples | Exemples | Ejemplos

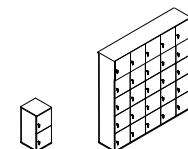

**Numero moduli min/max**  
 Modules number min/max  
 Nombre de modules min/max  
 Número de módulos min/máx





**1. Contenitore** | Storage | Rangement | Contenedor **Fin.** MK, ED  
L 160 P 43 H 173 cm | W 63" D 16 7/8" H 68 1/8"

**2. Contenitore** | Storage | Rangement | Contenedor **Fin.** MN, MK, MI  
L 250 P 43 H 93 cm | W 98 3/8" D 16 7/8" H 36 5/8"

**3. Contenitore** | Storage | Rangement | Contenedor **Fin.** MF, EB, EG, EI  
L 200 P 43 H 125 cm | W 78 3/4" D 16 7/8" H 49 1/4"  
**Schiena in tessuto** | Fabric back | Fond en tissu | Tresera de tejido







# Romolo

**I contenitori Romolo hanno due ante scorrevoli sovrapposte che possono essere in melaminico oppure in metacrilato intelaiato, e possono essere abbinati ad un vano a giorno superiore.**

Romolo is a storage system with sliding doors that can be in melamine or framed acrylic. It is available in many widths and heights. An upper open shelving can be added to the sliding door storage.

**Ante** | Doors | Portes | Puertas

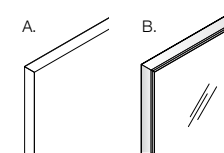

**A. Senza profilo B. Con profilo sp 5 mm**  
 A. Without profile B. With 5 mm (1/4") profile  
 A. Without profile B. Avec profil ép. de 5 mm  
 A. Sin perfil B. Con perfil esp. 5 mm

Les rangements Romolo ont deux portes coulissantes chevauchées qui peuvent être réalisées en mélamine ou en méthacrylate avec cadre, et peuvent être combinées avec un compartiment supérieur ouvert.

Los armarios Romolo tienen dos puertas deslizantes que se superponen y que pueden ser de melamina o metacrilato enmarcado. Pueden combinarse con un compartimento superior abierto.

**Scocca**  
 Body  
 Corps  
 Cuerpo



**Ante**  
 Panels  
 Panneaux  
 Paneles



**Contenitori**  
 Storage  
 Rangements  
 Contenedores

**Contenitori** | Storage | Armoires | Armarios

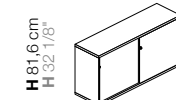

L 160/180/200/240 - P 37/46,6 cm  
 W 63"-70 7/8"-78 3/4"-94 1/2" - D 14 5/8"-18 3/8"

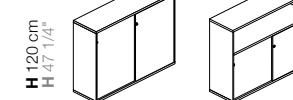

L 160/180/200/240 - P 37/46,6 cm  
 W 63"-70 7/8"-78 3/4"-94 1/2" - D 14 5/8"-18 3/8"

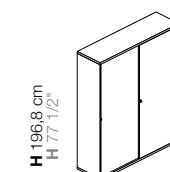

L 160/180/200/240 - P 37/46,6 cm  
 W 63"-70 7/8"-78 3/4"-94 1/2" - D 14 5/8"-18 3/8"





2.

**1. Contenitore** | Storage | Rangement | Contenedor **Fin.** MI, MK  
**L** 200 **P** 47 **H** 120 cm | **W** 78 3/4" **D** 18 1/2" **H** 47 1/4"

**2. Contenitore** | Storage | Rangement | Contenedor **Fin.** MT, MZ  
**L** 480 **P** 47 **H** 120 cm | **W** 189" **D** 18 1/2" **H** 47 1/4"

**3. Contenitore** | Storage | Rangement | Contenedor **Fin.** MK, MJ  
**L** 160 **P** 47 **H** 81 cm | **W** 63" **D** 18 1/2" **H** 31 7/8"  
 Porta piante | Planter | Cache-pot | Jardinera  
**H** 21 cm | **H** 8 1/4"



3.



# Blade X

## .credenza

Blade X presenta una serie di contenitori dedicati. Le ante hanno larghezza 70 cm e sono dotate di maniglia in metallo integrata e verniciata con lo stesso colore dei piedi metallici. È disponibile una versione con sezione a giorno e ripiani vetro fumé.

Blade X presents a series of dedicated storage. The doors are 70 cm (27 1/2") in width and are equipped with an integrated metal handle and painted in the same colour as the metal feet. A version with open storage and smoked glass shelves is available.

Blade X dispose de meubles spécifiques. Les portes sont en largeur 70 cm et disposent d'une poignée métallique intégrée dans la même finition que le piètement. Une version avec compartiment ouvert et étagère en verre fumé est également proposée.

Blade X presenta una serie de almacenamiento dedicado. Las puertas son de 70 cm de ancho y están equipadas con un mango de metal integrado y pintadas del mismo color que las patas de metal. Almacenamiento y estantes de vidrio ahumado está disponible.

- Scocca  
Body  
Corps  
Cuerpo → MEL
- Ante  
Panels  
Panneaux  
Paneles → MEL LGN
- Piedi/maniglie  
Feet/handles  
Pieds/poignées  
Pies/tiradores → EPX



**Credenze**  
Sideboards  
Buffets  
Aparador

Credenze | Credenzas | Buffets | Muebles

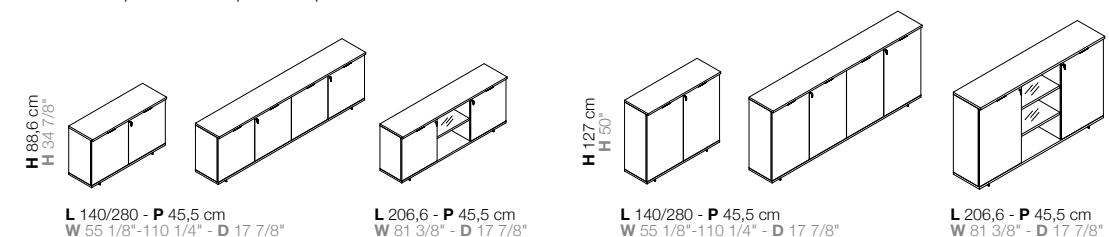





2.

**1. Credenza** | Sideboard | Buffet | Aparador **Fin. AK, EO**  
**L 206 P 45 H 89 cm | W 81 1/8" D 17 3/4" H 35"**

**2. Credenza** | Sideboard | Buffet | Aparador **Fin. RG, EB**  
**L 280 P 45 H 89 cm | W 110 1/4" D 17 3/4" H 35"**

**3. Credenza** | Sideboard | Buffet | Aparador **Fin. RC, EN**  
**L 206 P 45 H 127 cm | W 81 1/8" D 17 3/4" H 50"**



3.



# Oasi .credenza

La credenza Oasi è disponibile in due versioni. La prima presenta due ante battenti laterali con maniglia integrata, un vano a giorno centrale con ripiano in vetro fumè e uno zoccolo frontale in metallo. La seconda ha invece 4 vani chiusi da ante e gambe in metallo verniciato che sollevano la scocca rispetto al pavimento.

The Oasi sideboard is available in two versions, one has two side hinged doors with integrated handle and a central open compartment with smoked glass shelf and a metal front finish plinth. The second has instead 4 compartments closed by doors and legs in painted metal that lift the shell with respect to the floor.

Le buffet Oasi est disponible en deux versions, l'une avec 3 compartiments dont 2 portes battantes et un compartiments ouvert doté d'une étagère en verre fumé, en appui au sol avec pieds en métal et un socle centrale en métal peint. La seconde comporte au contraire 4 compartiments fermés par des portes et des pieds en métal peint qui soulèvent la structure du sol.

El aparador Oasi está disponible en dos versiones, una tiene dos puertas laterales con bisagras y manija integrada y un compartimiento central abierto con estante de vidrio ahumado y un zócalo de metal con acabado frontal. El segundo tiene en cambio 4 compartimentos cerrados por puertas y patas de metal pintado que levantan la carcasa con respecto al suelo.

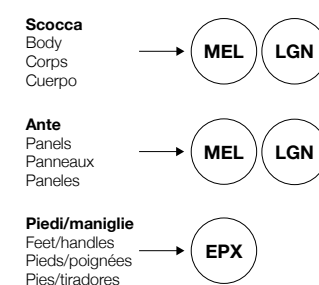

**Credenze**  
Sideboards  
Buffets  
Aparador

**Credenze** | Credenzas | Buffets | Muebles

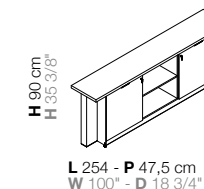
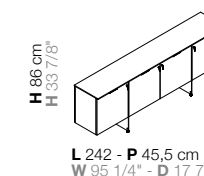





2.

**1. Credenza** | Sideboard | Buffet | Aparador **Fin. AK, EZ**  
 L 242 P 45 H 86 cm | W 95 1/4" D 17 3/4" H 33 7/8"

**2. Credenza** | Sideboard | Buffet | Aparador **Fin. ME, EI**  
 L 242 P 45 H 86 cm | W 95 1/4" D 17 3/4" H 33 7/8"

**3. Credenza** | Sideboard | Buffet | Aparador **Fin. NT, EZ**  
 L 254 P 47 H 90 cm | W 100" D 18 1/2" H 35 3/8"



3.



# Quattro

**Quattro è il sistema di pareti attrezzate pensato per essere semplice ed economico ma allo stesso tempo molto versatile ed elegante. Anche un semplice gioco di colori tra ante e scocca rende le composizioni incredibilmente piacevoli. È composto interamente da pannelli in melaminico di spessore 30 mm, ad eccezione di schiene ed ante che sono spesse 18 mm. Le ante battenti si possono sovrapporre, creando così composizioni dinamiche e adatte a diversi utilizzi. L'apertura è disponibile sia a 110° che a 180°.**

Quattro is the wall storage system designed to be easy and economical but very versatile and elegant at the same time. Even a simple play of colours between doors and frame makes every composition incredibly pleasant. It is entirely made of 30 mm (1 1/8") thick melamine panels, except for doors and backs which are 18 mm (3/4") thick. Hinged doors can be stacked, thus creating dynamic compositions suitable for different uses. Opening is available both at 110° and 180°.

Quattro est le système d'armoire-paroi équipé conçu pour être simple et économique mais en même temps élégant et polyvalent. Même un simple jeu de couleurs entre portes et corps rend les compositions incroyablement agréables. Elle est entièrement composée par panneaux mélaminés de 30 mm d'épaisseur, sauf fond et portes qui ont une épaisseur de 18 mm. Les portes battentes de hauteur différentes peuvent être combinées, afin de créer composition dynamiques et adaptés à différentes utilisations. L'ouverture est disponible à 110° et 180°.

Quattro es el sistema de paredes equipadas diseñado para ser simple y barato pero al mismo tiempo muy versátil y elegante. También un simple juego de colores entre las puertas y el cuerpo hace las composiciones increíblemente agradables. Está compuesto en su totalidad por paneles de melamina de 30 mm de espesor, a excepción de las traseras y de las puertas que tienen 18 mm de espesor. Las puertas batientes se pueden superponer creando así composiciones dinámicas adecuadas para diferentes usos. La apertura está disponible tanto a 110° como a 180°.

**Scocca**  
Body  
Corps  
Cuerpo



**Ante**  
Panels  
Panneaux  
Paneles



**Contenitori**  
Storage  
Rangements  
Contenedores

**Modularità** | Modularity | Modularité | Modularidad

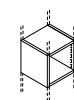
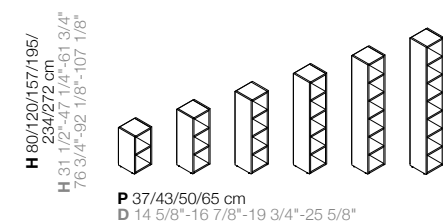

**L 40/45/50 cm**  
W 15 3/4"-17 3/4"-19 3/4"

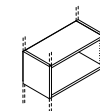

**L 80/90/100 cm**  
W 31 1/2"-35 3/8"-39 3/8"



1.





2.

**1. Contenitore** | Storage | Rangement | Contenedor **Fin. MI, MC**  
**L 350 P 65 H 270 cm | W 137 3/4" D 25 5/8" H 106 1/4"**

**2. Contenitore** | Storage | Rangement | Contenedor **Fin. MN, MI, MY**  
**L 500 P 50 H 230 cm | W 196 7/8" D 19 3/4" H 90 1/2"**

**3. Contenitore** | Storage | Rangement | Contenedor **Fin. MD**  
**L 670 P 50 H 230 cm | W 263 3/4" D 19 3/4" H 90 1/2"**

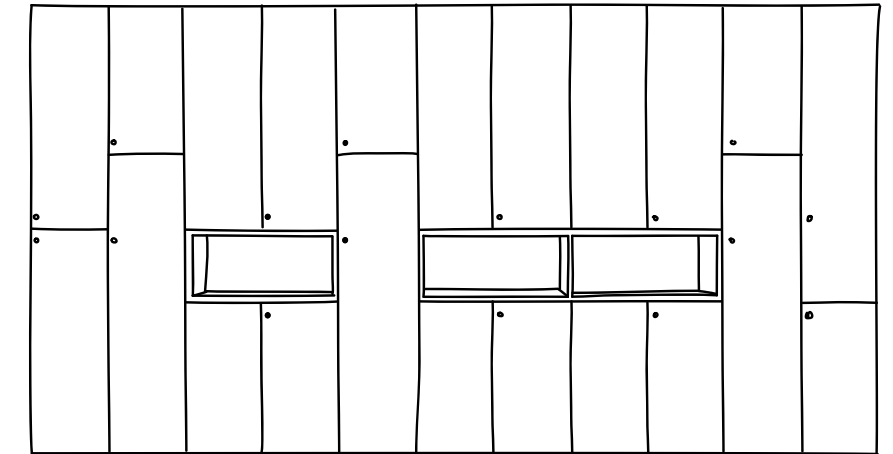

3.





# accessori

Accessories  
Accessoires  
Accesorios

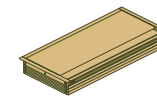

256

**Moduli  
elettrificati**

Power modules  
Modules d'électrification  
Módulos de electrificación



258

**Elettrificazione  
verticale**

Vertical cable management  
Électrification verticale  
Electrificación vertical





Basic

PLA\*

\*Nero  
\*Black  
\*Noir  
\*Negro



Magic Top

EPX



Flip-Top

EPX



Passacavi rotondo | Round grommet |  
Passecables rond | Pasacables redondo

CRM

PLA\*

\*Nero o bianco  
\*Black or white  
\*Noir ou blanc  
\*Negro o blanco



Flat

EPX

LGN



Cover

EPX



Push

EPX

LGN

CUO



Dot

PLA\*

\*Nero o bianco  
\*Black or white  
\*Noir ou blanc  
\*Negro o blanco

# Moduli elettrificati

Power modules | Modules d'électrification | Módulos de electrificación

I moduli per elettrificazione Alea possono essere di tipo passacavi (Magic Top, Flip Top e Passacavi rotondo) da abbinare all'elemento Basic (ciabatta configurabile), oppure possono avere prese integrate, come per Flat, Cover, Push e Dot. Le prese elettriche disponibili sono: Schuko, presa Unel, presa Francia/Belgio, presa svizzera e presa inglese, USB charger. Mentre i dispositivi per la gestione dati sono: RJ, HDMI, USB dati.

I moduli elettrificati, a seconda della versione, sono disponibili in varie finiture/materiali.

Alea's electrification modules can be of the grommet type (Magic Top, Flip Top and Round Grommet) to be combined with the Basic element (configurable power strip), or they can have integrated sockets, as for Flat, Cover, Push and Dot. The available sockets are: Schuko, Unel socket, France/Belgium socket, Swiss socket and English socket, USB charger. While the data devices are: RJ, HDMI, USB data.

Depending on the version, the electrified modules are available in various finishes/materials.

Les modules d'électrification Alea peuvent être de type passe-câbles (Magic Top, Flip Top et passe-câbles rond) à assortir avec l'élément basic (multiprise configurable), ou ils peuvent avoir des prises intégrées, soit Flat, Cover et Dot. Les prises de courant disponibles sont: Schuko, prise Unel, prise France/Belgique, prise Suisse et prise Anglaise, USB chargeur. Les dispositifs de gestion des données sont: RJ, HDMI, données USB.

Les modules électrifiés, selon la version, sont disponibles en différentes finitions/matériaux.

Los módulos de electrificación Alea pueden ser de tipo pasacables (Magic Top, Flip Top y pasacable redondo) para combinar con el elemento BASIC (regleta configurable), o pueden llevar tomas de corriente integradas, como en el caso de Flat, Cover, Push y Dot. Las tomas de corriente disponibles son: Enchufe Schuko, enchufe Unel, enchufe Francia/Bélgica, enchufe suizo y enchufe inglés, cargador USB. En cambio los dispositivos para la gestión de datos son: RJ, HDMI, USB.

Dependiendo de la versión, los módulos electrificados están disponibles en varios acabados/materiales.



# Elettrificazione verticale

Vertical cable management | Électrification verticale |  
Electrificación vertical

**L'elettrificazione verticale può essere invece realizzata con vertebre (A) in policarbonato traslucido fissate ai piani, con guaine raccoglicavi in plastica (B) o con guaine passacavi in rete (C) del diametro di 30 mm realizzate in PET di colore bianco o nero che possono essere tagliate a misura in loco.**

Vertical electrification can be provided with a translucent polycarbonate spine wire management system (A) secured to tops, plastic cable tidy sleeving (B) or with 30 mm diameter cable management mesh (C) made of PET in white or black colour that can be cut to size on site.

Pour l'électrification verticale sont disponibles les vertèbres (A) en polycarbonate translucide fixées aux plans, gaines en plastique (B), ou gaines passe-câbles (C) de 30 mm de diamètre en PET de couleur blanche ou noire qui peuvent être découpés sur place.

La electrificación vertical puede realizarse con vértebras (A) de policarbonato translúcido fijadas en los tableros, con cubiertas flexibles de plástico (B) o con cubierta flexible en red (C) para cables D. 30 mm hechas de PET blanco o negro que pueden ser cortadas a medida en el sitio.

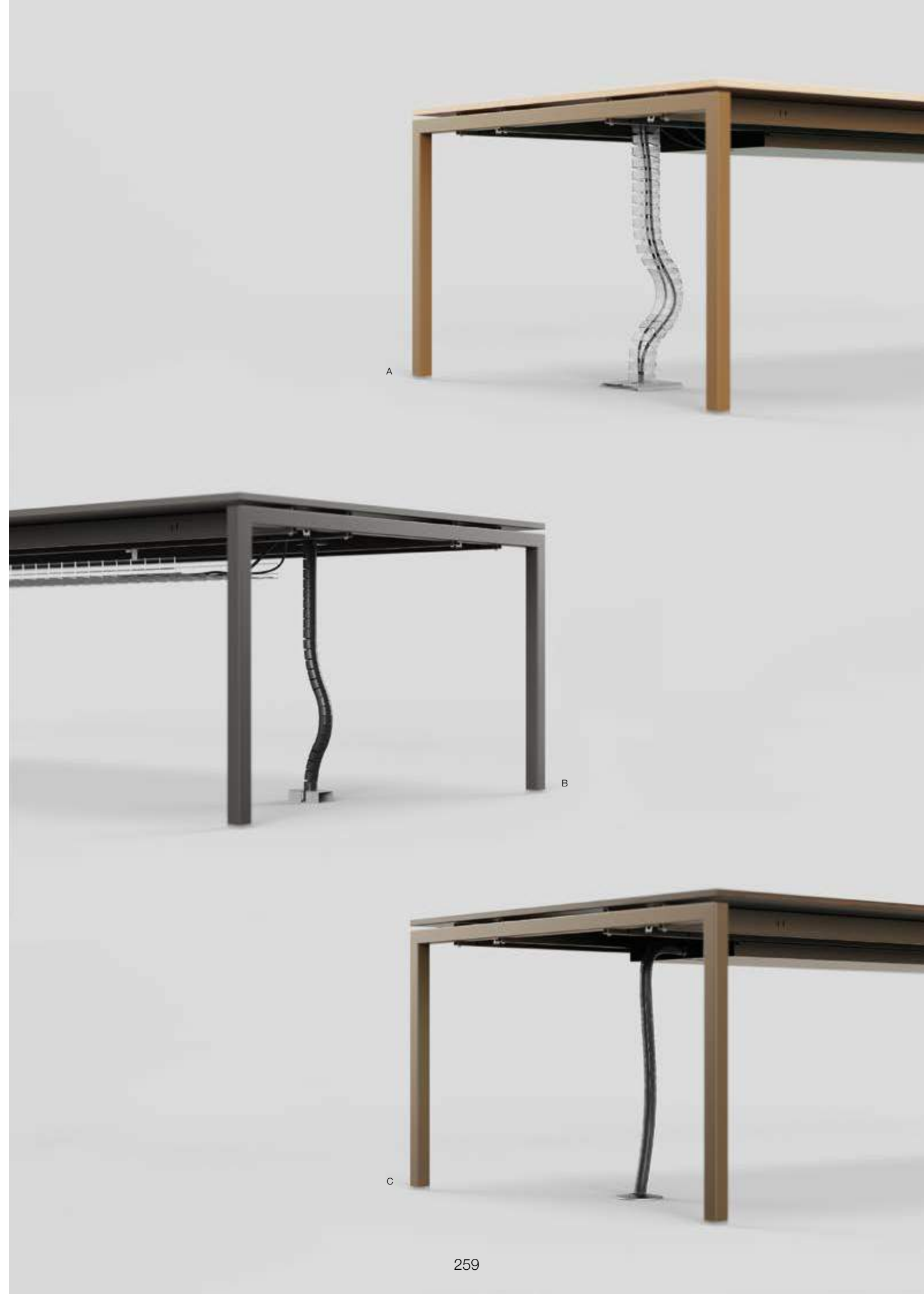





262  
F40

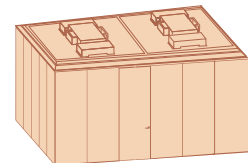

270  
F65

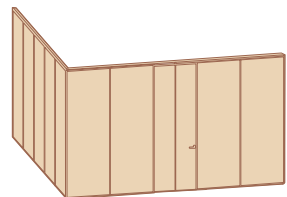

276  
A65



spazi

Spaces  
Espaces  
Espacios



# F40

**Negli spazi ampi nasce il bisogno di isolarsi per una call oppure per un meeting privato, o più semplicemente per ricavarsi un momento di concentrazione maggiore. La collezione di cabine e pods F40 nasce proprio per rispondere a queste esigenze. Si distingue per il design lineare e la rapidità di assemblaggio in cantiere, con conseguente abbattimento dei costi per il cliente. F40 viene presentato nelle dimensioni standard 120x100 cm (One), 220x100 cm (Two), 220x220 cm (Four), 260x260 cm (Six), 260x345 cm (Eight) e dispone di una gamma di arredi interni dedicati ed opzionali, per chi desidera un pacchetto completo.**

In large spaces there is a need to isolate oneself for a call or a private meeting, or simply to find a moment of greater concentration. The F40 pods and phone booths collection was created to meet these needs. It stands out for its linear design and rapidity of assembly on site, with consequent reduction of costs for the customer. F40 is presented in the standard dimensions: One 120x100 cm (47 1/4"x39 3/8"), Two 220x100 cm (86 5/8"x39 3/8"), Four 220x220 cm (86 5/8"x 86 5/8"), Six 260x260 cm (102 3/8"x 102 3/8"), Eight 260x345 cm (102 3/8"x 135 7/8") and has a range of dedicated and optional interior furnishings, for those who want a complete package.

Dans les grands espaces, il est nécessaire de s'isoler pour un appel ou une réunion privée, ou simplement pour trouver un moment de plus grande concentration. La collection de pods et cabines F40 a été créée pour répondre à ces besoins. Il se distingue par sa conception linéaire et la rapidité de son montage sur site, avec une réduction conséquente des coûts pour le client. F40 est présenté dans les dimensions standard 120x100 cm (One), 220x100 cm (Two), 220x220 cm (Four), 260x260 cm (Six), 260x345 cm (Eight) et dispose d'une gamme d'aménagements intérieurs dédiés et optionnels, pour ceux qui veulent un ensemble complet.

En los grandes espacios surge la necesidad de aislarse para una llamada o una reunión privada, o simplemente para encontrar un momento de mayor concentración. La colección de pods y cabinas F40 se creó para satisfacer estas necesidades. Destaca por su diseño lineal y la rapidez de montaje en obra, con la consiguiente reducción de costes para el cliente. F40 se presenta en los tamaños estándar 120x100 cm (One), 220x100 cm (Two), 220x220 cm (Four), 260x260 cm (Six), 260x345 cm (Eight) y cuenta con una gama de mobiliario interior dedicado y opcional, para quienes deseen un paquete completo.

**Pannelli esterni**  
External panels  
Panneaux extérieurs  
Paneles exteriores



**Pannelli fonoassorbenti**  
Acoustic panels  
Panneaux insonorisants  
Paneles fonoabsorbentes

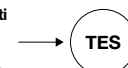

**Privacy**  
Privacy  
Privacidad



**Relax**  
Relax  
Relax



**Riunioni**  
Meeting  
Réunions  
Reuniones





2.



3.



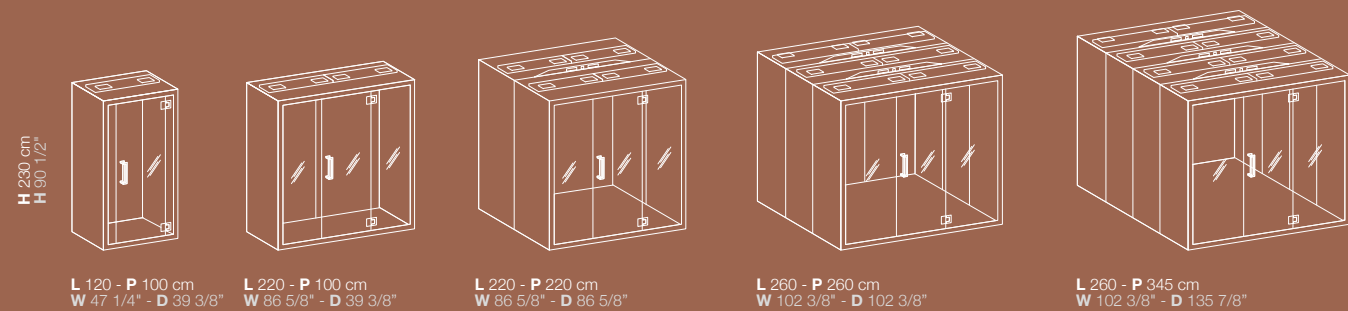

Opzioni allestimento | Outfitting options | Options d'équipement | Opciones de equipamiento

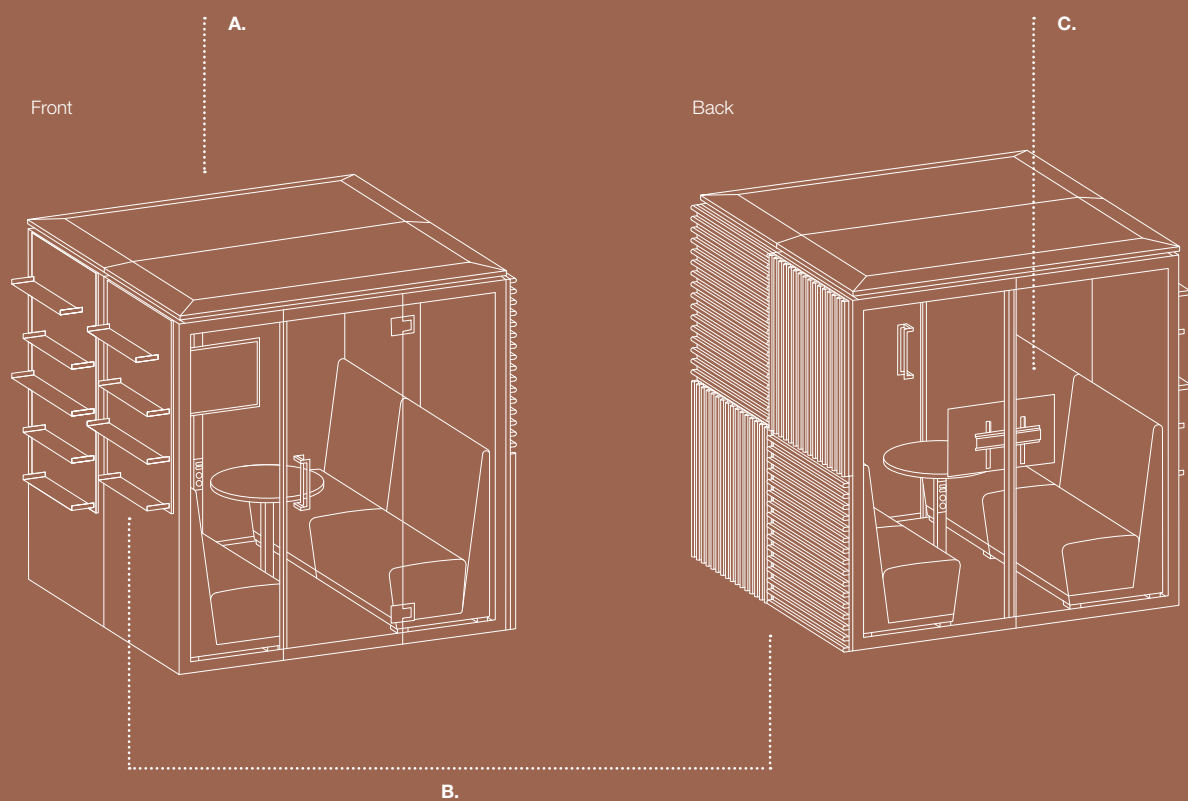

- A.**
- Accessori interni:**
- ventilazione/illuminazione dimmerabile
  - impianto di condizionamento
  - sanificatore d'aria
- Interior accessories:
- dimmable ventilation/lighting
  - air conditioning system
  - air sanitiser
- Accessoires intérieurs:
- ventilation/éclairage à gradation
  - système de climatisation
  - assainisseur d'air
- Accesorios interiores:
- ventilación/iluminación regulable
  - sistema de aire acondicionado
  - higienizador de aire
- B.**
- Accessori esterni:**
- pannelli fonoassorbenti decorati con listoni in legno
  - mensole in metallo
  - schiena scrivibile
- External accessories:
- sound-absorbing panels decorated with wooden planks
  - metal shelves
  - writable back
- Accessoires externes:
- panneaux insonorisants décorés de planches de bois
  - étagères en métal
  - panneau arrière inscriptible
- Accesorios externos:
- paneles fonoabsorbentes decorados con tablas de madera
  - estantes metálicos
  - trasera escribible
- C.**
- Arredo interno:**
- divanetti
  - tavoli/mensole elettrificati
  - porta TV
- Interior furniture:
- sofas
  - electrified tables/shelves
  - TV stands
- Mobilier intérieur:
- canapé
  - tables/étagères électrifiées
  - support écran TV
- Mobiliario interior:
- sofás
  - mesas/estanterías electrificadas
  - soportes de TV





**1. One Fin.** DC  
L 120 P 100 H 230 cm | W 47 1/4" D 39 3/8" H 90 1/2"

**2. Two Fin.** DG, MD  
L 220 P 100 H 230 cm | W 86 5/8" D 39 3/8" H 90 1/2"

**3. Four Fin.** DI, MI, ES, ET  
L 220 P 220 H 230 cm | W 86 5/8" D 86 5/8" H 90 1/2"

**4. Six Fin.** DC, MI  
L 260 P 260 H 230 cm | W 102 3/8" D 102 3/8" H 90 1/2"

**5. Eight Fin.** DC, UV Print  
L 260 P 345 H 230 cm | W 102 3/8" D 135 7/8" H 90 1/2"





# F65

**F65 è un sistema freestanding di pareti mobili per la creazione di cellule multifunzione di grande comfort e privacy all'interno di spazi open-space. F65 è adatto a soluzioni su richiesta, anche di grandi dimensioni.**

F65 is a freestanding system of movable walls for the creation of multifunctional cells of great comfort and privacy in open spaces. F65 is designed for solutions on demand, especially in big sizes.

F65 est un système autoportant, composé de cloisons mobiles qui permettent de créer des cellules multifonctionnelles, en offrant une grande confidentialité dans les "open space". F65 convient aux solutions à la demande, en particulier aux installations de grande envergure.

F65 es un sistema independiente de paredes móviles para la creación de módulos multifuncionales de gran comodidad y privacidad en espacios abiertos. F65 es adecuado para soluciones a petición, especialmente las de gran tamaño.

**Pannelli esterni**  
External panels  
Panneaux extérieurs  
Paneles exteriores



**Pannelli fonoassorbenti**  
Acoustic panels  
Panneaux insonorisants  
Paneles fonoabsorbentes

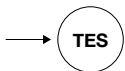

**Struttura**  
Structure  
Structure  
Estructura



**Layout**  
Layout  
Layout  
Layout



**Privacy**  
Privacy  
Privacy  
Privacidad



**Uffici privati**  
Private offices  
Bureaux privés  
Oficinas privadas



**Riunioni**  
Meeting  
Réunions  
Reuniones







Es. configurazioni | configurations ex. |  
ex. de configuracions | ej. de configuraciones

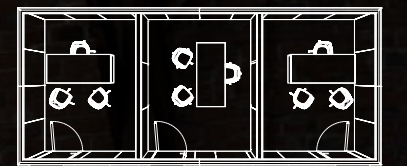
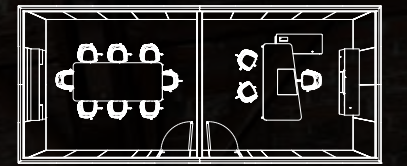



**F65** 3000 x 3000 mm +  
118 1/8" x 118 1/8" +

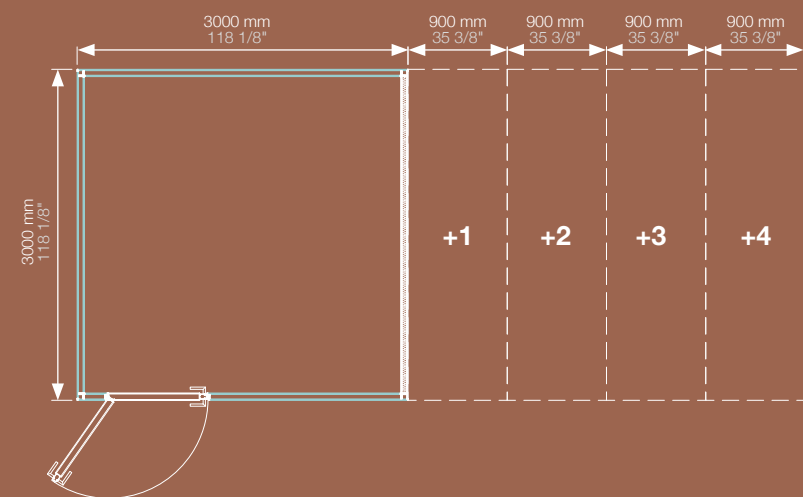

**Pianta**  
Plan view  
Vue en plan  
Vista en planta

**F65** 4000 x 4000 mm +  
157 1/2" x 157 1/2" +

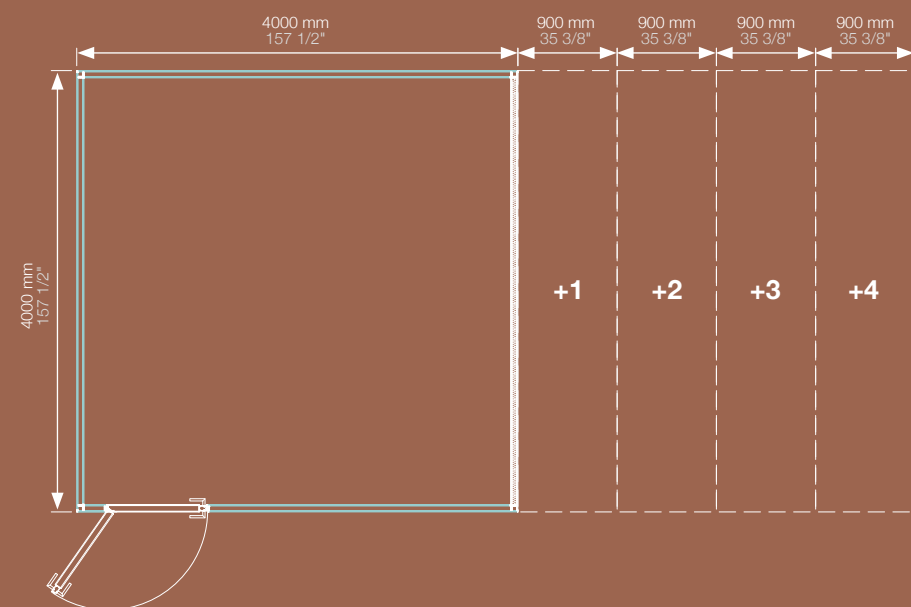

**Pianta**  
Plan view  
Vue en plan  
Vista en planta

**F65** H 2300 mm  
90 1/2"

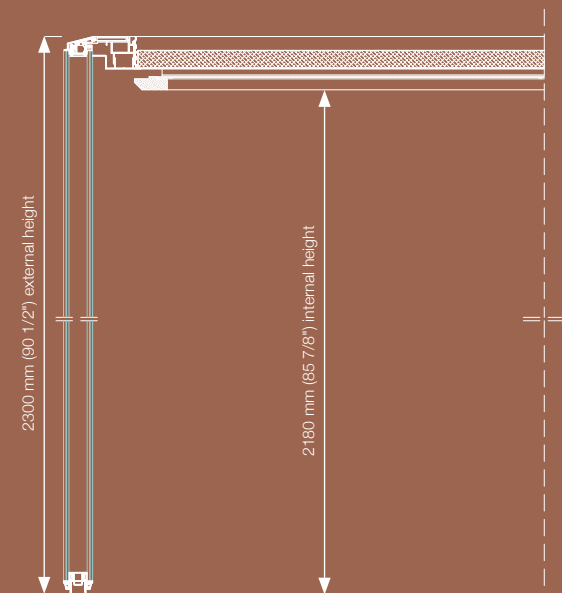

**Sezione verticale**  
Vertical section  
Section vertical  
Section vertical







# A65

**A65 è la parete divisoria modulare di Alea. Disponibile con vetro singolo, vetro doppio oppure pannelli ciechi, attrezzabile con porte battenti o scorrevoli.**

**Si caratterizza per un design minimalista che ne esalta la trasparenza. La coplanarità di porte e pannelli parete permettono di avere una continuità superficiale.**

**Le pareti sono disponibili in due tipologie, Standard ed Evo, per rispondere al meglio alle diverse esigenze progettuali.**

A65 is Alea's modular partition wall, available in single-glazed, double-glazed or solid panel versions, which can be fitted with hinged or sliding doors.

Its minimalist design enhances the transparency and flushness between doors and wall elements, allowing for surface continuity.

Partition walls are available in two types, Standard and Evo, to best meet different design requirements.

A65 est la cloison de séparation modulaire d'Alea. Disponible en simple vitrage, double vitrage ou panneaux pleins, il peut être équipé de portes battantes ou coulissantes.

Il se caractérise par un design minimaliste qui améliore sa transparence, la coplanarité des portes et des panneaux muraux permet une continuité de surface.

Les cloisons de séparation sont disponibles en deux versions, Standard et Evo, pour répondre au mieux aux différentes exigences de conception.

A65 es la mampara divisoria de Alea. Disponible con cristal único, cristal doble o paneles ciegos, puede equiparse con puertas batientes o correderas.

Se caracteriza por un diseño minimalista que realza su transparencia. Además, la coplanaridad de las puertas y los paneles de pared permiten la continuidad de la superficie.

Las mamparas divisorias están disponibles en dos tipologías, Standard y Evo, para responder mejor a los diferentes requisitos de diseño.

**Pannelli esterni**  
External panels  
Panneaux extérieurs  
Paneles exteriores



**Struttura**  
Structure  
Structure  
Estructura



**Layout**  
Layout  
Layout  
Layout



**Privacy**  
Privacy  
Privacy  
Privacidad



**Uffici privati**  
Private offices  
Bureaux privés  
Oficinas privadas



**Riunioni**  
Meeting  
Réunions  
Reuniones





**Angoli curvi**  
 Curved corners  
 Angles arrondis  
 Esquinas curvas



**Dettaglio sezione**  
 Section detail  
 Détail de la section  
 Detalle de la sección



**Tipologie maniglia** | Handle types | Types de poignées | Tipología de tiradores



**Man 001.1**

**Man 001.2**

**Alea Design Pull Handle**

**Tipologie profilo** | Profile types | Types de profil | Tipología de perfil



**Standard**



**Design minimal**  
Minimal design  
Design minimaliste  
Diseño minimalista



**Evo**



**Regolabile**  
Adjustable  
Réglable  
Regolabile

**Profilo Standard** | Standard profile | Profil Standard | Perfil Standard

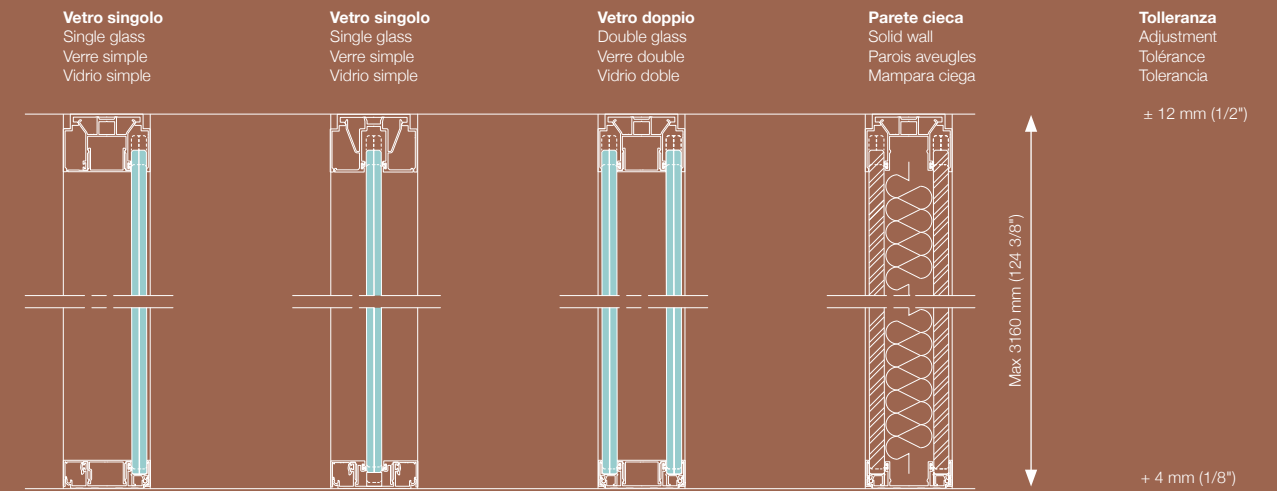

**Profilo Evo** | Evo profile | Profil Evo | Perfil Evo

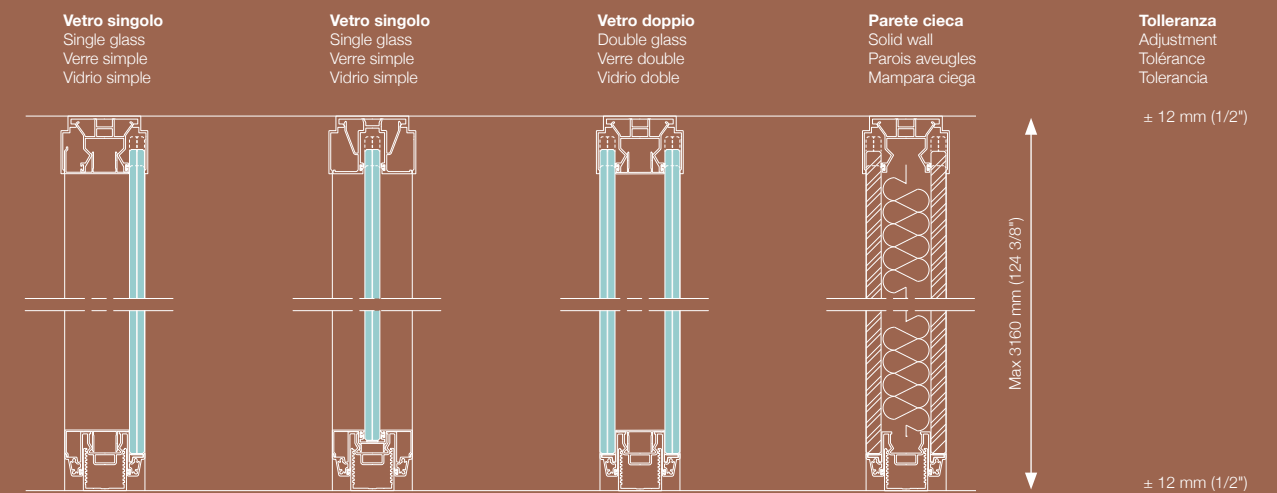

**Angoli curvi - Profilo Standard**

Curved corners - Standard profile | Angles arrondis - Profil Standard | Esquinas curvas - Perfil Standard

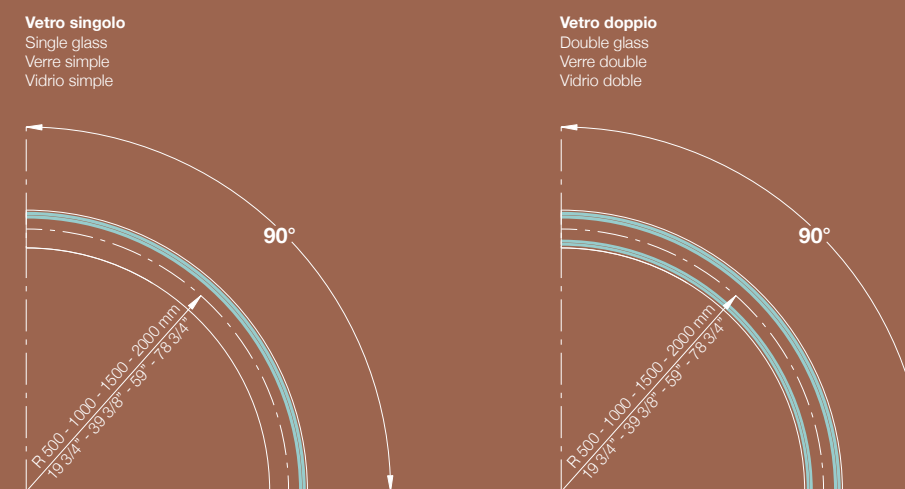



Porte | Doors | Portes | Puertas

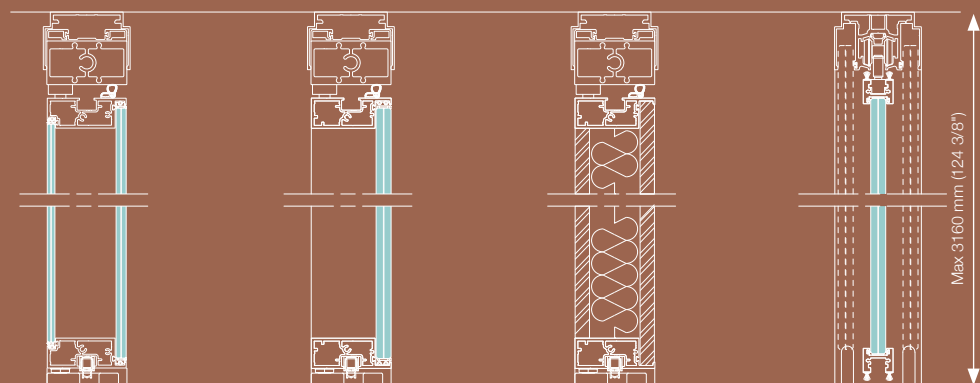

**Sezioni verticali**  
Vertical section  
Sections verticales  
Secciones verticales

**Vetro doppio**  
Double glass  
Verre double  
Vidrio doble

**Vetro singolo**  
Single glass  
Verre simple  
Vidrio simple

**Cieca**  
Solid door  
Aveugle  
Ciega

**Scorrevole**  
Sliding door  
Coulissante  
Corredera

Porte battenti | Pivot doors | Portes pivotantes | Puertas batientes

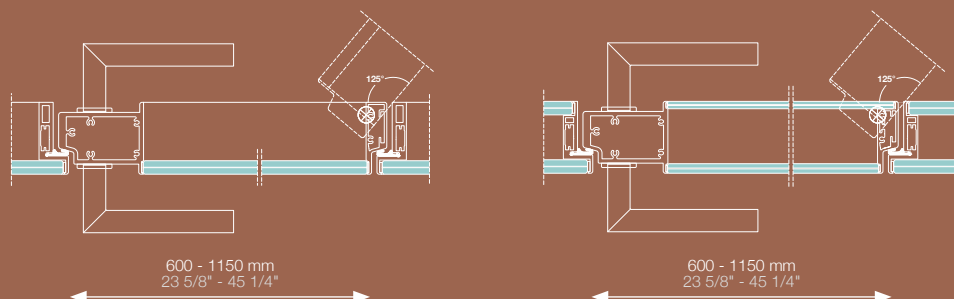

**Sezioni orizzontali**  
Horizontal section  
Sections horizontales  
Secciones horizontales

**Vetro singolo**  
Single glass  
Verre simple  
Vidrio simple

**Vetro doppio**  
Double glass  
Verre double  
Vidrio doble

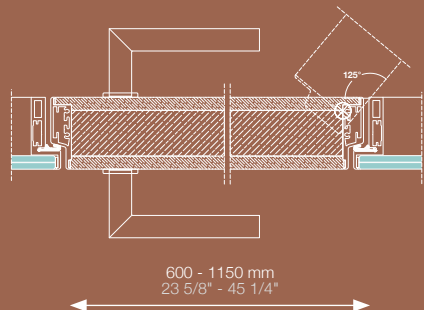

**Cieca**  
Solid door  
Aveugle  
Ciega

Porte scorrevoli | Sliding doors | Portes coulissantes | Puertas correderas

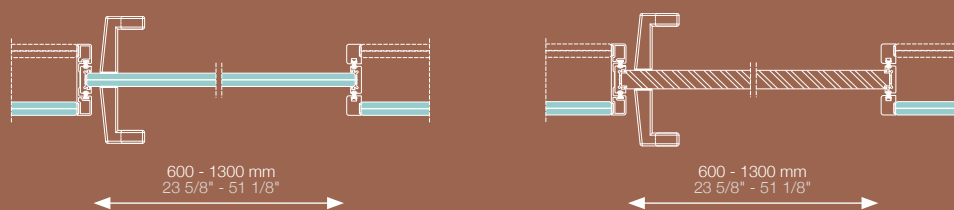

**Sezioni orizzontali**  
Horizontal section  
Sections horizontales  
Secciones horizontales

**Vetro singolo**  
Single glass  
Verre simple  
Vidrio simple

**Cieca**  
Solid door  
Aveugle  
Ciega







# materiali e finiture



**MEL** **Melaminico**  
Melamine | Mélaminé | Melaminico

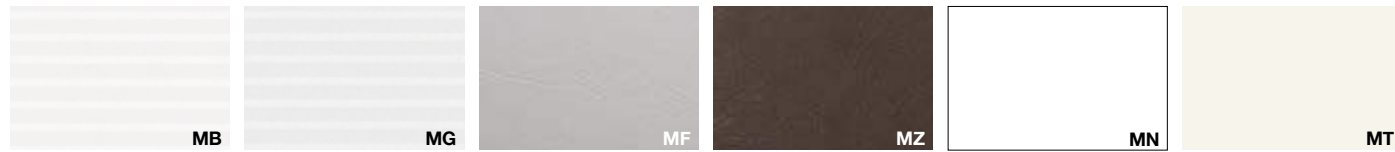

**Bianco rigato**  
Rippled effect white  
Blanc avec rayures en sérigraphie  
Blanco rayado

**Grigio rigato**  
Rippled effect grey  
Gris avec rayures en sérigraphie  
Gris rayado

**Nichel**  
Nickel  
Nickel  
Niquel

**Cacao**  
Cocoa  
Cacao  
Cacao

**Bianco**  
White  
Blanc  
Blanco

**Talco**  
Talco  
Talco  
Talco

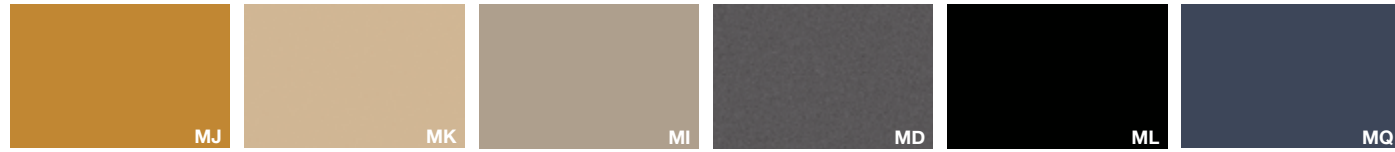

**Ocra**  
Ochre  
Ocre  
Ocre

**Safari**  
Safari  
Safari  
Safari

**Noisette**  
Noisette  
Noisette  
Noisette

**Ardesia**  
Ardesia  
Ardesia  
Pizarra

**Nero**  
Black  
Noir  
Negro

**Blu notte**  
Night blue  
Bleu nuit  
Azul noche



**Rovere chiaro**  
Light oak  
Chêne clair  
Roble claro

**Rovere americano**  
American oak  
Chêne américain  
Roble americano

**Rovere grigio**  
Grey oak  
Chêne gris  
Roble gris

**Rovere moro**  
Dark oak  
Chêne foncé  
Roble oscuro

**Noce Canaletto**  
Canaletto Walnut  
Noyer Canaletto  
Nogal Canaletto

**Noce scuro**  
Dark walnut  
Noyer foncé  
Nogal oscuro

**LGN** **Legno**  
Wood | Bois | Madera

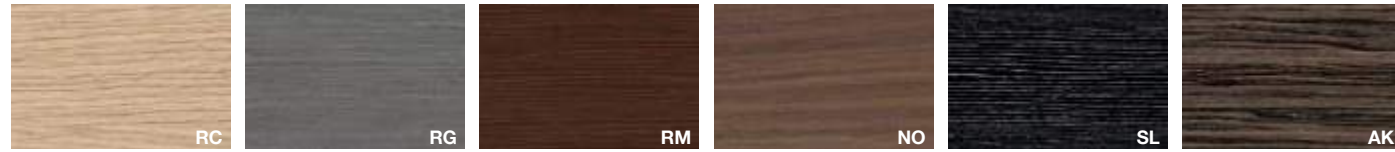

**Rovere chiaro**  
Light oak  
Chêne clair  
Roble claro

**Rovere grigio fumo**  
Smoke grey oak  
Chêne gris de fumée  
Roble gris humo

**Rovere moro**  
Dark oak  
Chêne foncé  
Roble oscuro

**Noce Canaletto**  
Canaletto Walnut  
Noyer Canaletto  
Nogal Canaletto

**Ebano Silver**  
Silver ebony  
Ebony Silver  
Ebano plata

**Ebano Makassar**  
Makassar ebony  
Ebony Makassar  
Ebano Makassar



**Noce termocotto**  
Heat-treated walnut  
Noyer thermo traité  
Nogal termotratado

**FNX** **Fenix**  
Fenix | Fenix | Fenix



**Bianco**  
White  
Blanc  
Blanco

**Beige Arizona**  
Arizona beige  
Beige Arizona  
Beige Arizona

**Blu Fes**  
Fes blue  
Bleu Fes  
Azul Fes

**Grigio Bromo**  
Bromo grey  
Gris Bromo  
Gris Bromo

**Verde Comodoro**  
Comodoro green  
Vert Comodoro  
Verde Comodoro

**Nero**  
Black  
Noir  
Negro



**Rosso Jaipur**  
Jaipur red  
Rouge Jaipur  
Rojo Jaipur

**VTR** **Vetro**  
Glass | Verre | Vidrio



**Bianco**  
White  
Blanc  
Blanco

**Argento**  
Silver  
Argent  
Plata

**Grigio scuro**  
Dark grey  
Gris foncé  
Gris oscuro

**Noisette**  
Noisette  
Noisette  
Noisette

**Ardesia**  
Ardesia  
Ardesia  
Pizarra

**Moka**  
Mocha  
Moka  
Cafe



**Nero**  
Black  
Noir  
Negro

**Arancione**  
Orange  
Orange  
Naranja

**Rosso "F"**  
Red "F"  
Rouge "F"  
Rojo "F"

**Rubino**  
Orange  
Ruby  
Rubi

**Indaco**  
Indigo  
Indigo  
Azul Indigo

**Azzurro**  
Blue  
Bleu  
Azul

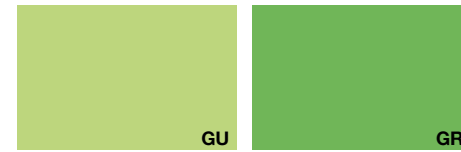

**Verde**  
Green  
Vert  
Verde

**Cedro**  
Lime green  
Vert Cédrat  
Verde Cedro

**CUO** **Cuoio**  
Leather | Cuir | Cuero

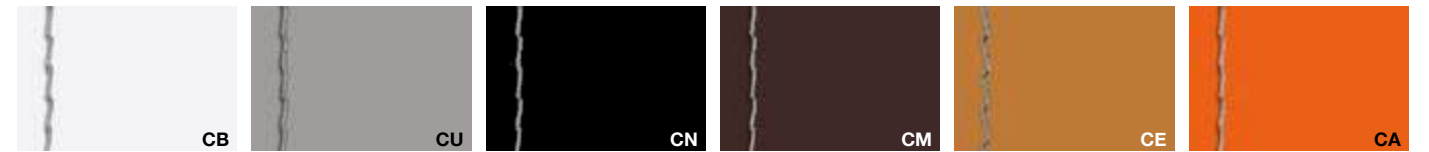

**Bianco**  
White  
Blanc  
Blanco

**Alluminio**  
Aluminium  
Aluminium  
Aluminio

**Nero**  
Black  
Noir  
Negro

**Testa di moro**  
Brown  
Tête de maure  
Marron oscuro

**Caramello**  
Caramel  
Caramel  
Caramelo

**Arancione**  
Orange  
Orange  
Naranja

**GRES** **Gres**  
Porcelain tiles | Grès cérame | Gres porcelánico



**Nero**  
Black  
Noir  
Negro

**Basalt**  
Basalt  
Basalt  
Basalt

**Calacatta**  
Calacatta  
Calacatta  
Calacatta

**Pulpis**  
Pulpis  
Pulpis  
Pulpis

**Corten**  
Corten  
Corten  
Corten



**MTC Metacrilato**  
Acrylic | Méthacrylate | Metacrilato



**Bianco opalino**  
Opaline white  
Blanc opalin  
Blanco opaco

**Trasparente**  
Transparent  
Transparent  
Transparente

**Rosso trasparente**  
Red transparent  
Rouge transparent  
Rojo transparente

**Blu trasparente**  
Blue transparent  
Bleu transparent  
Azul transparente

**Bianco satinato**  
Satin-finish white  
Blanc satiné  
Blanco satinado

**Grigio fumè satinato**  
Satin-finish smoky grey  
Gris satiné  
Gris satinado



**Arancione satinato**  
Satin-finish orange  
Orange satiné  
Naranja satinado

**Blu satinato**  
Satin-finish blue  
Bleu satiné  
Azul satinado

**Verde satinato**  
Satin-finish green  
Vert satiné  
Verde satinado

**TES Tessuto**  
Fabric | Tissu | Tejido

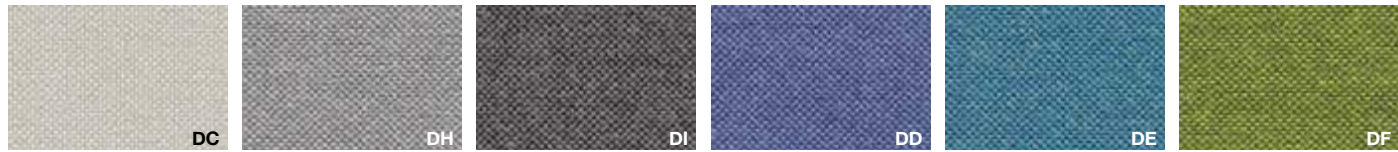

**Beige**  
Beige  
Beige  
Beige

**Grigio chiaro**  
Light grey  
Gris clair  
Gris claro

**Ardesia**  
Ardesia  
Ardesia  
Pizarra

**Blu avio**  
Avio blue  
Bleu avio  
Azul avio

**Acquamarina**  
Aquamarine  
Alugue-marine  
Aguamarina

**Verde primavera**  
Spring green  
Vert printemps  
Verde primavera



**Salvia**  
Sage  
Sauge  
Salvia

**Arancio**  
Orange  
Orange  
Naranja

**Corallo**  
Coral  
Corail  
Coral

**OSB OSB**  
OSB | OSB | OSB



**OSB**  
OSB  
OSB  
OSB

**EPX Epossidico**  
Epoxy | Époxy | Epoxi

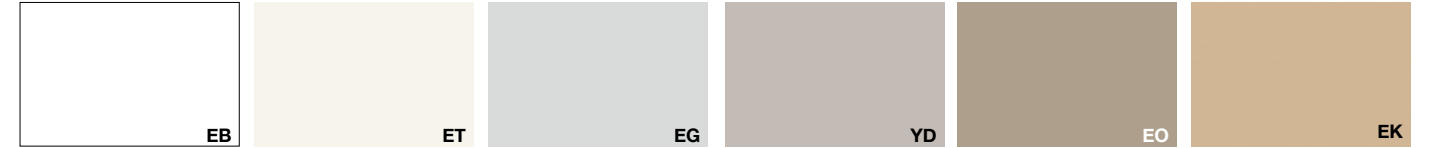

**Bianco**  
White  
Blanc  
Blanco

**Talco**  
Talco  
Talco  
Talco

**Grigio**  
Grey  
Gris  
Gris

**Beige Arizona**  
Arizona beige  
Beige Arizona  
Beige Arizona

**Noisette**  
Noisette  
Noisette  
Noisette

**Safari**  
Safari  
Safari  
Safari



**Rame**  
Copper  
Cuivre  
Cobre

**Rosso Jaipur**  
Jaipur red  
Rouge Jaipur  
Rojo Jaipur

**Bronzo**  
Bronze  
Bronze  
Bronce

**Blu notte**  
Night blue  
Bleu nuit  
Azul noche

**Grigio Bromo**  
Bromo grey  
Gris Bromo  
Gris Bromo

**Ardesia**  
Ardesia  
Ardesia  
Pizarra



**Verde Comodoro**  
Comodoro green  
Vert Comodoro  
Verde Comodoro

**Nero**  
Black  
Noir  
Negro

**AL Alluminio**  
Aluminium | Aluminium | Aluminio



**Alluminio**  
Aluminium  
Aluminium  
Aluminio

**BR Brill**  
Brill | Brill | Brill



**Brill**  
Brill  
Brill  
Brill

**CRM Inox lucido**  
Stainless Steel | Inox brossé poli | Acero inoxidable



**Inox lucido**  
Stainless Steel  
Inox brossé poli  
Acero inoxidable



**Concept, visual & graphic design**

Alea marketing + communication

**Design**

Filippon & Mirto Antonel

**Art direction**

Mirto Antonel

**Si ringrazia M.artedesign**

[martedesign.it](http://martedesign.it)

AC/CACD/AC

**Le immagini dei prodotti visibili all'interno di questo catalogo sono inserite a scopo puramente indicativo**

The images of the products visible in this catalogue are included for information purposes only  
Les images des produits visibles dans ce catalogue sont incluses à titre informatif uniquement  
Las imágenes de los productos visibles en este catálogo se incluyen sólo con fines informativos

alea  
aleaoffice.com



**GLOBAL HEADQUARTERS AND SHOWROOM** : Via Col de Rust, 19 - 33070 Sarone (PN) - Italia : Tel ++39 0434 777 333  
email: info@aleaoffice.com **PARIS SHOWROOM** : 176 Avenue Charles de Gaulle 92200, Neuilly-sur-Seine - France **NORTH AMERICAN**  
**HEADQUARTERS** : Midtown 2, 3449 NE 1st Avenue L-32, Miami, FL 33137 - USA : Tel ++1 305 470 1200 - email: info@alea-usa.com  
**ALEA UK OFFICE AND SHOWROOM** : 50-54 Clerkenwell Road, London EC1M 5PS - email: info@aleaoffice.com