

naught**one**

# contents

Issue 5.0

## Environment

### Page 4

Information about naughtone's approach to the environment.

## Inspire

### Pages 6–55

Inspirational images from a broad selection of case studies and more recent product photography.

## Products

### Pages 56–151

A double page spread per product range to break down the range options in detail.

Further product information including downloadable images and CAD blocks can be found on our website

[www.naughtone.com](http://www.naughtone.com)

Please contact naughtone or your furniture dealer directly for any other enquiries.

58	<b>Trace</b> Small Tables	106	<b>Viv</b> Chair / Lounge / Barstool
60	<b>Trace</b> Large Tables	108	<b>Viv</b> 4 Star / 5 Star
62	<b>Fold</b> Steel Leg Coffee and Cafe Tables	110	<b>New</b> <b>Viv</b> Highback / Highback Lounge
64	<b>Fold</b> Steel Leg Tables	112	<b>Always</b> Chair
66	<b>Frog</b> Tables	114	<b>Always</b> 4 Star / 5 Star
68	<b>Dalby</b> Wooden Leg Coffee and Cafe Tables	116	<b>Always</b> Lounge Chair
70	<b>Dalby</b> Wooden Leg Tables	118	<b>New</b> <b>Fiji</b> Chair / Sofa
72	<b>Ped</b> Table	120	<b>Hush</b> Low Chair
74	<b>Megaped</b> Table	122	<b>Hush</b> Chair
76	<b>New</b> <b>Ali</b> Table	124	<b>Hush</b> Low Sofa
78	<b>Knot</b> Table	126	<b>Hush</b> Sofa
80	<b>Riley</b> Table	128	<b>Cloud</b> Quilt Armchair / Sofa
82	<b>Shard</b> Coatstand	130	<b>Cloud</b> Plain Armchair / Sofa
84	<b>Sideboard</b> Storage	132	<b>Cloud</b> Booth Seating
86	<b>Softbox</b> Storage	134	<b>Cloud</b> Desk
88	<b>Pollen</b> Stool / Table	136	<b>New</b> <b>Pullman</b> Booth
90	<b>Pinch</b> Stool	138	<b>New</b> <b>Hue</b> Seating
92	<b>New</b> <b>Lasso</b> Seating	140	<b>Busby</b> Chair
94	<b>Construct</b> Low Stool / Barstool	142	<b>Portion</b> Chair / Sofa / Bench
96	<b>Bounce</b> Chair	144	<b>Hatch</b> Modular Seating
98	<b>Polly</b> Chair / Barstool	146	<b>Symbol</b> Modular Seating
100	<b>Polly</b> 4 Star / 5 Star	148	<b>Clyde</b> Club Chair / Sofa / Bench
102	<b>Polly</b> Wood Chair / Armchair / Barstool	150	<b>Rhyme</b> Modular Seating
104	<b>Viv</b> Wood Chair / Lounge / Barstool		

# about us

At naughtone we like to keep things easy; Useful, Beautiful Furniture quite simply explains what we do. Even our name naughtone means no-nonsense.

naughtone is a British company founded in 2005 by industry professionals. We like to consider ourselves friendly experts and we strive to make the process of selecting, purchasing and receiving our products as easy and informative as possible.



Although naughtone is based in Britain our products are available globally. We design and develop in the UK and our manufacturing strategy supports consistent lead times, pricing and environmental factors in our international markets.

We have our own showrooms in the UK and North America and our products can be seen in furniture dealer showrooms all over the world.

naughtone furniture is used by some of the most influential brands in commerce and culture; there is no better proof of the relevance and application of the product range. We have built this useful collection of products by reacting quickly to market demands with as straightforward solution as possible.

In 2019, naughtone was honoured with a prestigious Queen's Award for Enterprise in International Trade, after expanding rapidly to accommodate international growth. The Queen's Awards for Enterprise recognise and celebrate business excellence across the UK.

naughtone was also placed number 1 in The Sunday Times SME Export Track 100 for 2017, named as The Telegraph's Fastest Growing British Export SME 2018, placed number 22 in The Sunday Times Lloyds SME Export Track 100 for 2018 and placed number 81 in the Sunday Times Virgin Atlantic Fast Track 100 for 2018.

To view our full range of products visit [www.naughtone.com](http://www.naughtone.com)



## Environment

naughtone has always considered the environment throughout our design and manufacturing process. We understand that as we continue to grow, so does our potential impact on our surroundings. As most of our raw materials are simple, we have great control over their sources, and are proud to be able to offer FSC® certified upholstered products and use recycled metals in our table ranges.

The addition of our North American manufacturing provision also helps to keep manufacturing miles to a minimum, as our market continues to grow in the USA. Finally, naughtone offers a 'bring back' programme, where the client is able to return the product to our factory, where we will be happy to breakdown and recycle the parts for you.

For more information please contact your sales representative or visit

[www.naughtone.com/green-credentials](http://www.naughtone.com/green-credentials)



We have a comprehensive range of downloadable product brochures for every naughtone product. These have been designed to document all the relevant product information in one easy to use extended product brochure. These cover all frequently asked questions and are handy when specifying a project.

Every product range now has a dedicated extended brochure that is available for download from the product pages on the website and through the resources area.



### 1 Design

Every aspect of the naughtone product ranges has been designed with the environment considered, from ethical material choice and production efficacy to storage efficiency and ease of disassembly.

Dense foam sets and resilient fabrics are selected for their longevity and effectiveness across sectors. Durable high quality finishes such as powder coated bases in a range of colours allow clients the freedom of finish options. Finish samples are available allowing clients to make informed decisions and retain to add to their finish libraries for future reference.

### 2 Raw Material

Local supply of raw materials is employed for the production of our products when possible, procured from suppliers that are quality inspected for extraction methods and meet the highest environmental standards.

### 3 Production

As many of our products are assembled by hand the energy expenditure wasted from machinery during the production process is kept to a minimum.

All fabrics are cut to ensure optimum efficiency with fabric usage and reduced waste consumption per unit.

All production sites have recycling facilities for any excess product that cannot be used elsewhere, which is then managed by a professional third party.

### 4 Distribution

Distribution of naughtone products generally occurs directly between the manufacturing site to the client. Production is localised when possible to the US or UK regions, reducing the carbon footprint and miles travelled for each product.

Many items are flat packed for delivery or shipped disassembled with efficient, minimised packaging; optimizing the transportation vessel space.

### 5 Usage

naughtone products do not require energy or water to function, thus no environmental exchange takes place and no waste is generated during the life of the product.

The only foreseeable need is the cleaning of the product for general maintenance. This includes regular vacuuming to remove dirt and dust particles on upholstery items, and using a dry or damp cloth to wipe non-upholstery items.

This is recommended for all products utilised under conditions of normal wear and is expected to have negligible environmental impacts.

### 6 End of Life

Although our products are durable and demonstrate timeless design, naughtone products are manufactured in such a way that they can be easily disassembled at the end of life and most of the componentry can be either recycled or re-used as applicable.

As a company we are also happy to accept the return of products, to help re-home or recycle furniture or components at the end of the products useful life.



FSC® certified products available upon request



naughtone offers PEFC certified products



# inspire

Inspirational images from a broad selection of case studies and recent product photography

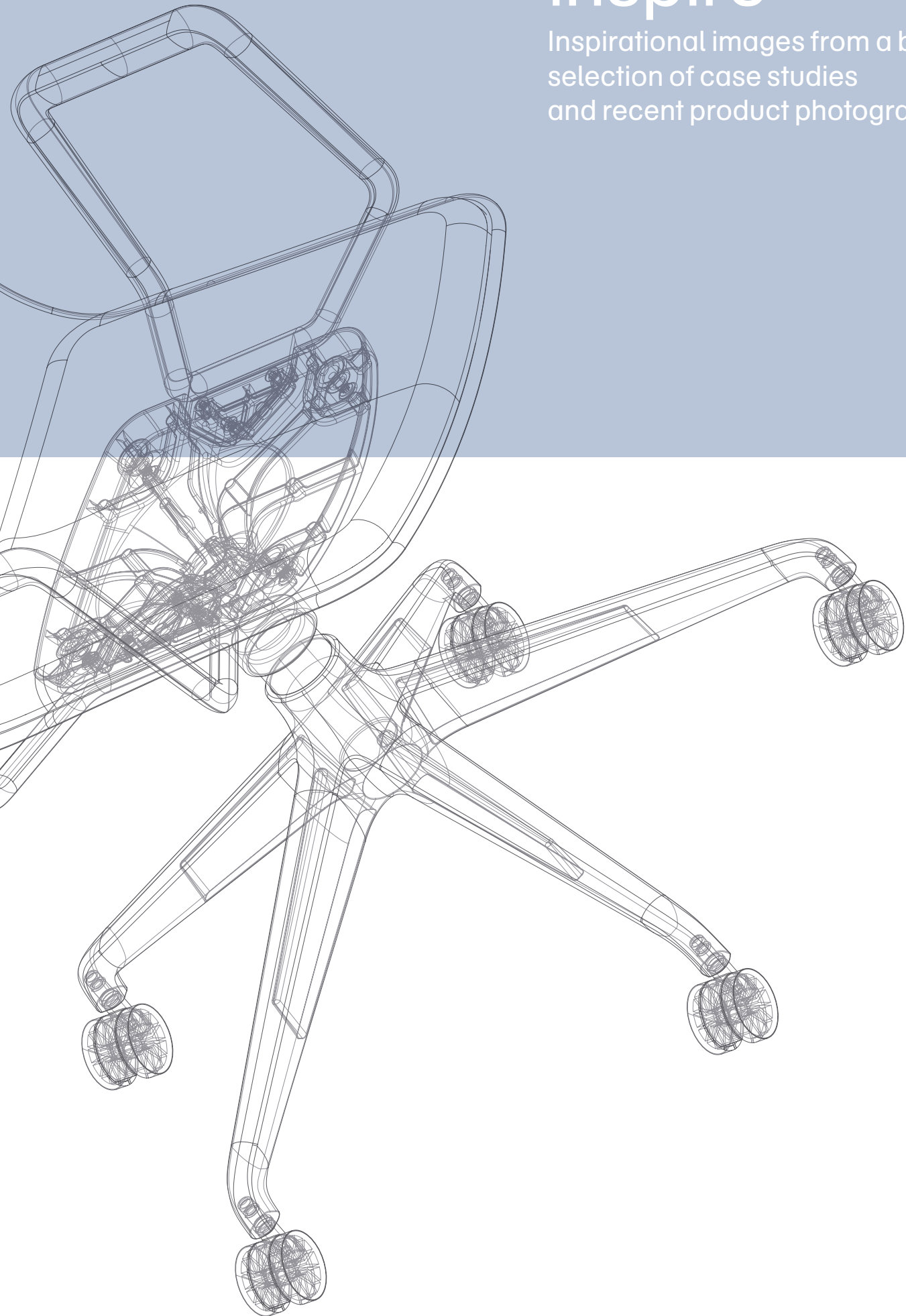



Cambridge Judge  
Business School  
Cambridge, UK



# meeting

# Croxley Park

Watford, UK

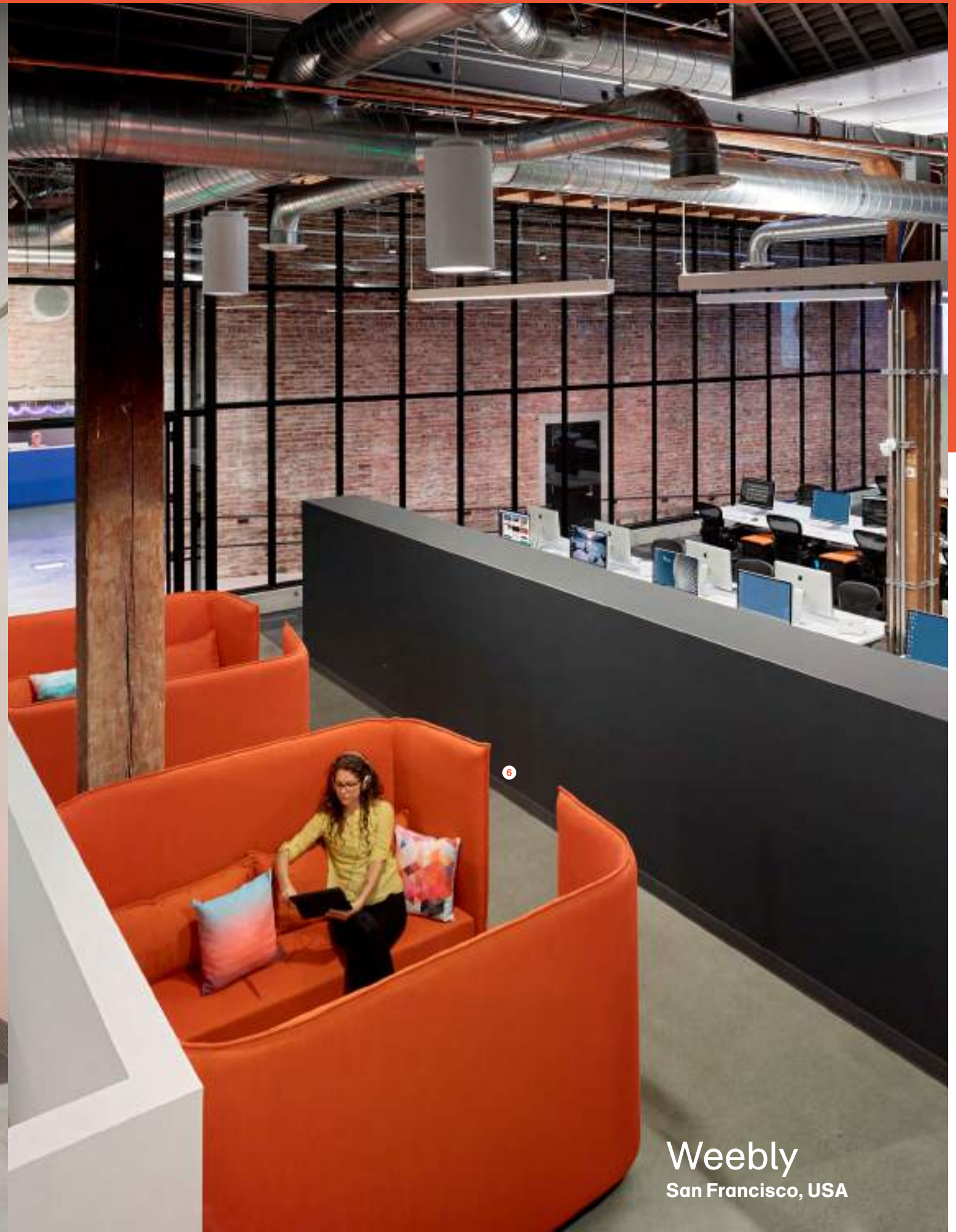

# Weebly

San Francisco, USA





break out

# Technology Company

Minnesota, USA





# break out



MSV Housing Association  
Manchester, UK



working



Government Contact Centre  
Manchester, UK



# learning



1

Etsy  
New York, USA





working



Nielsen  
Tel Aviv, Israel



# learning



break out



Herman Miller Showroom  
London, UK

# Technology Company

Minnesota, USA

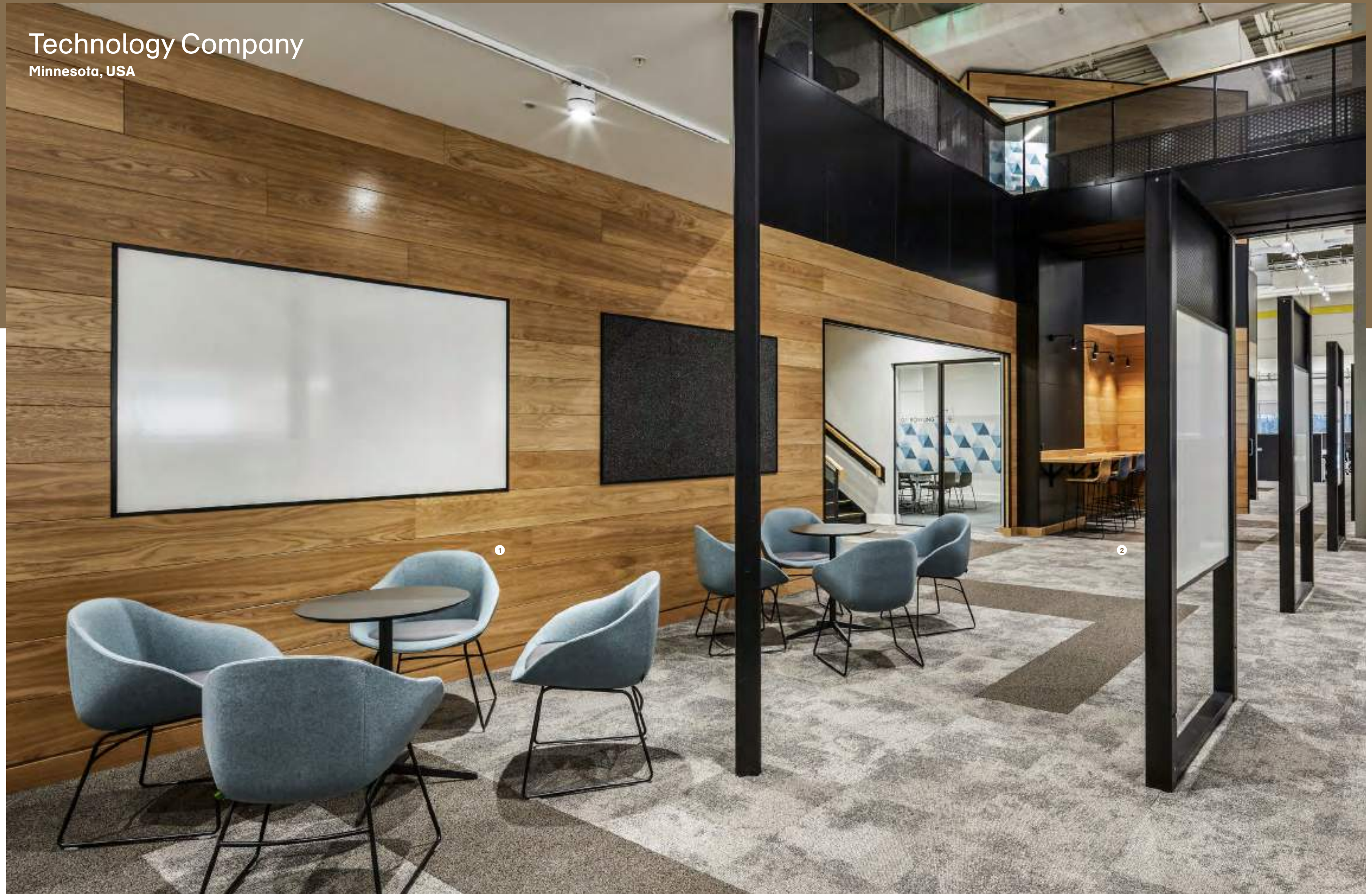



WSP  
Birmingham, UK



University of Northampton  
Northampton, UK



# AutoRek

Glasgow, UK





# meeting

# Veracruz Concert Hall

Foro Boca, Mexico

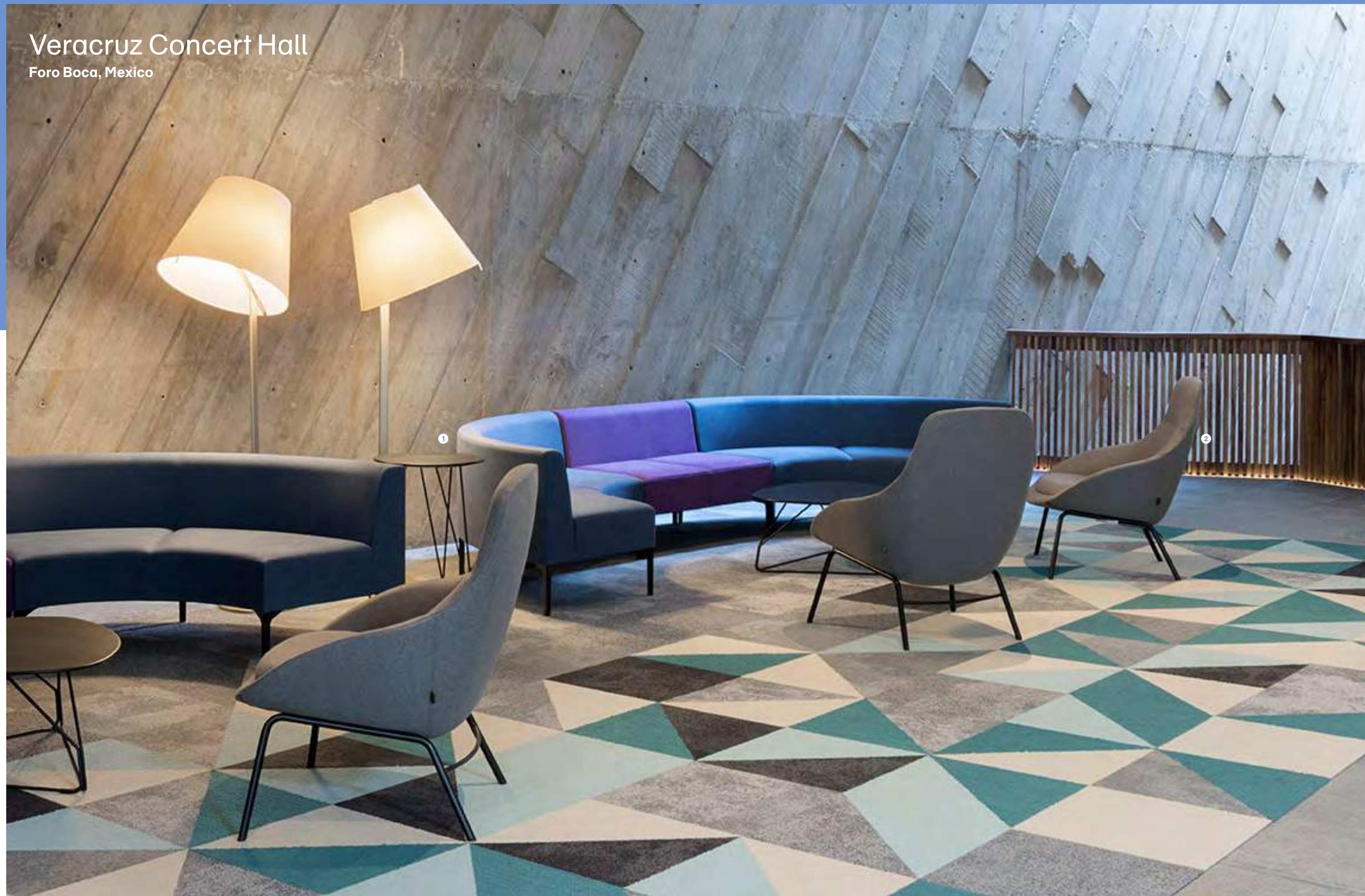



Rudding Park  
Harrogate, UK

# customisation

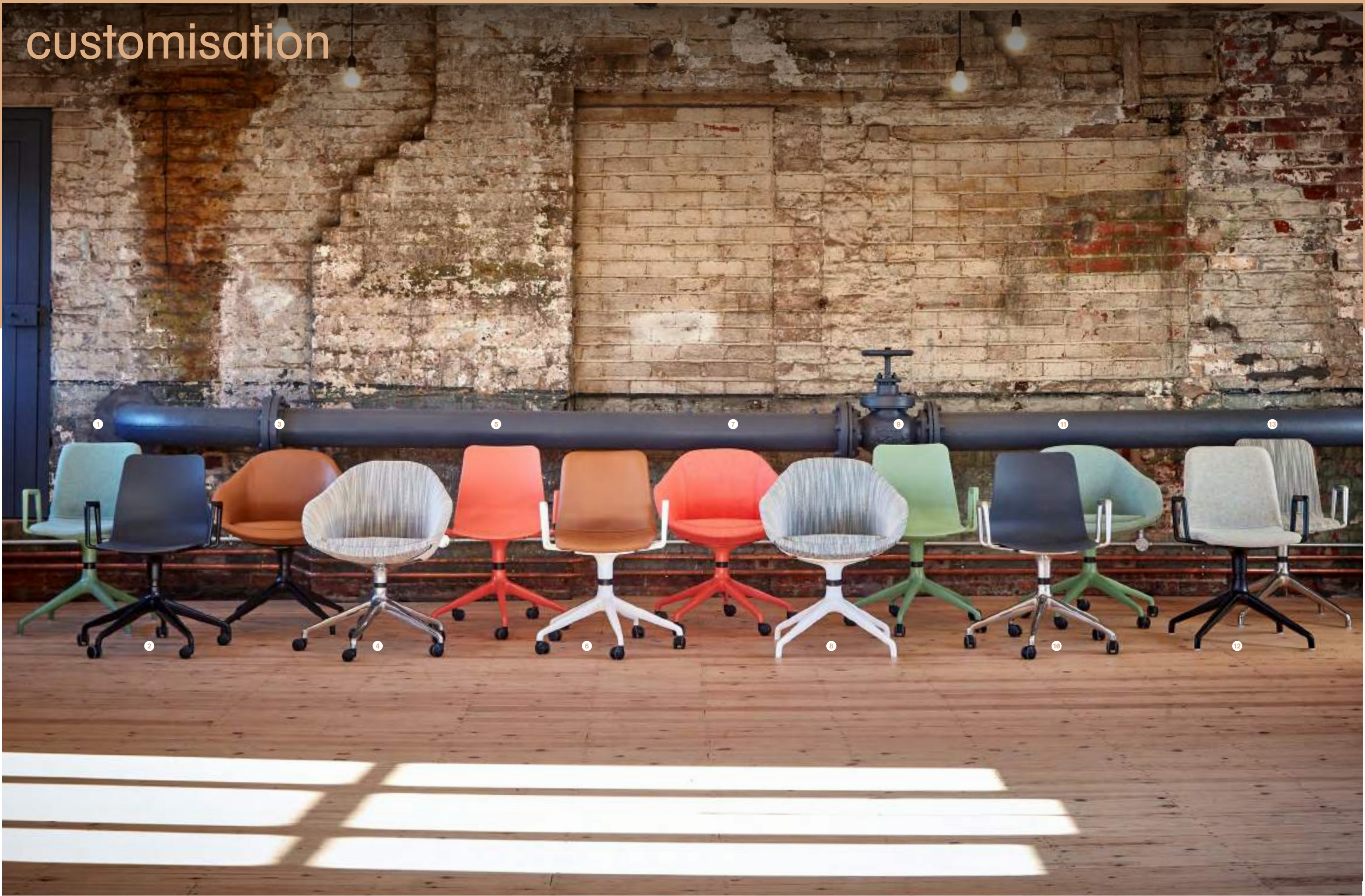

# products

A double page spread per product range to break down the range options in detail



58	<b>Trace</b> Small Tables	106	<b>Viv</b> Chair / Lounge / Barstool
60	<b>Trace</b> Large Tables	108	<b>Viv</b> 4 Star / 5 Star
62	<b>Fold</b> Steel Leg Coffee and Cafe Tables / Benches	110	<b>New</b> <b>Viv</b> Highback / Highback Lounge
64	<b>Fold</b> Steel Leg Tables	112	<b>Always</b> Chair
66	<b>Frog</b> Tables	114	<b>Always</b> 4 Star / 5 Star
68	<b>Dalby</b> Wooden Leg Coffee and Cafe Tables	116	<b>Always</b> Lounge Chair
70	<b>Dalby</b> Wooden Leg Tables	118	<b>New</b> <b>Fiji</b> Chair / Sofa
72	<b>Ped</b> Table	120	<b>Hush</b> Low Chair
74	<b>Megaped</b> Table	122	<b>Hush</b> Chair
76	<b>New</b> <b>Ali</b> Table	124	<b>Hush</b> Low Sofa
78	<b>Knot</b> Table	126	<b>Hush</b> Sofa
80	<b>Riley</b> Table	128	<b>Cloud</b> Quilt Armchair / Sofa
82	<b>Shard</b> Coatstand	130	<b>Cloud</b> Plain Armchair / Sofa
84	<b>Sideboard</b> Storage	132	<b>Cloud</b> Booth Seating
86	<b>Softbox</b> Storage	134	<b>Cloud</b> Desk
88	<b>Pollen</b> Stool / Table	136	<b>New</b> <b>Pullman</b> Booth
90	<b>Pinch</b> Stool	138	<b>New</b> <b>Hue</b> Seating
92	<b>New</b> <b>Lasso</b> Seating	140	<b>Busby</b> Chair
94	<b>Construct</b> Low Stool / Barstool	142	<b>Portion</b> Chair / Sofa / Bench
96	<b>Bounce</b> Chair	144	<b>Hatch</b> Modular Seating
98	<b>Polly</b> Chair / Barstool	146	<b>Symbol</b> Modular Seating
100	<b>Polly</b> 4 Star / 5 Star	148	<b>Clyde</b> Club Chair / Sofa / Bench
102	<b>Polly</b> Wood Chair / Armchair / Barstool	150	<b>Rhyme</b> Modular Seating
104	<b>Viv</b> Wood Chair / Lounge / Barstool		

# trace

Small Table



### About Trace

The Trace table range is an unmistakable product in the naughtone range. Traditionally seen with a clear glass top, Trace works equally well solid materials recessed flush into the steel frame. The repetition of shapes makes Trace an exquisitely balanced form, whether it's a coffee table or meeting table.

### Compliance

- SCS Indoor Advantage™ Gold Certificate
- naughtone is FSC® certified
- naughtone is FISP and ISO14001 certified
- Our tables are designed to meet or exceed all EN performance requirements per BS EN 15372:2016

### Sizes

All dimensions quoted are rounded to the nearest 5mm or nearest 1/2 inch

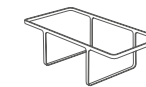

**TRACT**  
Trace Coffee Table  
mm  
W1100 D550 H350  
inch  
W43 D21.5 H14

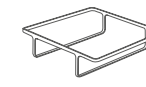

**TRASQ**  
Trace Square Coffee Table  
mm  
W850 D850 H250  
inch  
W33.5 D33.5 H10



**TRAST**  
Trace Side Table  
mm  
W450 D300 H450  
inch  
W17.5 D12 H17.5



**TRA600D**  
Trace Coffee Table  
600 Circular  
mm  
Dia 600 H350  
inch  
Dia 23.5 H14



**TRA800D**  
Trace Coffee Table  
800 Circular  
mm  
Dia 800 H350  
inch  
Dia 31.5 H14

### Top Options



**White / Black MFMDF**  
Circular tables matching edge band square edge



**Clear toughened glass**  
Circular tables have a square polished edge



**White marble**  
Circular tables have a square polished edge



**Oak veneer**  
Circular tables matching veneered square edge



**Walnut veneer**  
Circular tables matching veneered square edge



**Forbo Lino**  
8 x colours available  
Circular tables have a square polished MDF edge



**Reverse painted glass  
Black / Opti-white**  
Circular tables have a square polished edge



**Reverse painted glass  
in naughtone RAL colours**  
Circular tables have a square polished edge

### Base Options



**White / Black Powder Coated Base**  
Standard



**RAL Powder Coated Base**  
naughtone Colours



# trace

## Large Table



### About Trace

The Trace table range is an unmistakable product in the naughtone range. Traditionally seen with a clear glass top, Trace works equally well solid materials recessed flush into the steel frame. The repetition of shapes makes Trace an exquisitely balanced form, whether it's a coffee table or meeting table.

### Compliance

- SCS Indoor Advantage™ Gold Certificate
- naughtone is FSC® certified
- naughtone is FISP and ISO14001 certified
- Our tables are designed to meet or exceed all EN performance requirements per BS EN 15372:2016

### Sizes

All dimensions quoted are rounded to the nearest 5mm or nearest 1/2 inch

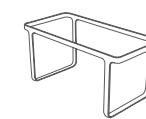

**TRA1600**  
Trace Table 1600 (4 Seater)  
mm  
W 1600 D 800 H 750  
inch  
W 63 D 31.5 H 29.5

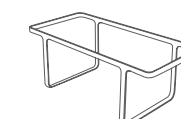

**TRA2200**  
Trace Table 2200 (6 Seater)  
mm  
W 2200 D 900 H 750  
inch  
W 86.5 D 35.5 H 29.5



**TRA1200D**  
Trace Table 1200 Circular  
mm  
Dia 1200 H 750  
inch  
Dia 47 H 29.5  
For table top options see Frog Table on Page 66  
Excludes clear glass



**TRA1400D**  
Trace Table 1400 Circular  
mm  
Dia 1400 H 750  
inch  
Dia 55 H 29.5  
For table top options see Frog Table on Page 66  
Excludes clear glass

### Top Options



**White / Black MFMD**  
Circular tables matching edge band square edge



**Clear toughened glass**  
Circular tables have a square polished edge



**Oak veneer**  
Circular tables matching veneered square edge



**Walnut veneer**  
Circular tables matching veneered square edge



**Forbo Lino**  
8 x colours available  
Circular tables have a square polished MDF edge



**Reverse painted glass**  
Black / Opti-white  
Circular tables have a square polished edge



**Reverse painted glass**  
in naughtone RAL colours  
Circular tables have a square polished edge

### Base Options



**White / Black Powder Coated Base**  
Standard



**RAL Powder Coated Base**  
naughtone Colours





# fold

Steel Leg Table



## About Fold

Strong and elegant, the Fold range is carefully proportioned to provide a simple and customisable surface. Taking its name from the folded steel frame, Fold is a low statement product that can be used with any chair or bench.

## Compliance

- SCS Indoor Advantage™ Gold Certificate
- naughtone is FSC® certified
- naughtone is FISP and ISO14001 certified
- Our tables are designed to meet or exceed all EN performance requirements per BS EN 15372:2016

## Sizes

All dimensions quoted are rounded to the nearest 5mm or nearest 1/2 inch



**FLD650DL**  
Fold 650 Circular Coffee Table  
mm Dia 650 H 350  
inch Dia 25.5 H 14



**FLD650SL**  
Fold 650 Square Coffee Table  
mm W 650 D 650 H 350  
inch W 25.5 D 25.5 H 14



**FLD850DL**  
Fold 850 Circular Coffee Table  
mm Dia 850 H 350  
inch Dia 33.5 H 14



**FLD850SL**  
Fold 850 Square Coffee Table  
mm W 850 D 850 H 350  
inch W 33.5 D 33.5 H 14



**FLD11X55L**  
Fold Rectangular Coffee Table  
mm W 1100 D 550 H 350  
inch W 43.5 D 21.5 H 14



**FLD650S**  
Fold 650 Square Cafe Table  
mm W 650 D 650 H 750  
inch W 25.5 D 25.5 H 29.5



**FLD850D**  
Fold 850 Circular Cafe Table  
mm Dia 850 H 750  
inch Dia 33.5 H 29.5

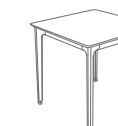

**FLD850S**  
Fold 850 Square Cafe Table  
mm W 850 D 850 H 750  
inch W 33.5 D 33.5 H 29.5



**FLDB125**  
Fold Bench1250  
mm W 1250 D 275 H 450  
inch W 49 D 11 H 17.5

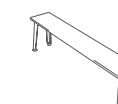

**FLDB145**  
Fold Bench1450  
mm W 1450 D 275 H 450  
inch W 57 D 11 H 17.5

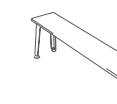

**FLDB165**  
Fold Bench1650  
mm W 1650 D 275 H 450  
inch W 65 D 11 H 17.5

## Base Finishes



White Powder Coated Frame Standard



Black Powder Coated Frame Standard



RAL Powder Coated Frame naughtone Colours

## Table Top Options



White / Black MFMDF edge banded



White / Black MFMDF with reverse chamfer, polished MDF edge



Forbo Lino with reverse chamfer edge 8 colours available



Oak Veneer with reverse chamfer, polished MDF edge



Walnut Veneer with reverse chamfer, polished MDF edge

## Bench Top Options



White / Black MFMDF with square edge band



Oak / Walnut Veneer with square edge band



Forbo Lino with square polished edge 8 colours available



# fold

## Steel Leg Table



### About Fold

Strong and elegant, the Fold range is carefully proportioned to provide a simple and customisable surface. Taking its name from the folded steel frame, Fold is a low statement product that can be used with any chair or bench.

### Compliance

- SCS Indoor Advantage™ Gold Certificate
- naughtone is FSC® certified
- naughtone is FISP and ISO14001 certified
- Our tables are designed to meet or exceed all EN performance requirements per BS EN 15372:2016

### Sizes

All dimensions quoted are rounded to the nearest 5mm or nearest 1/2 inch

<b>FLD12D</b> Fold 1200 Circular Table mm Dia 1200 H 750 inch Dia 47.5 H 29.5	<b>FLD14D</b> Fold 1400 Circular Table mm Dia 1400 H 750 inch Dia 55 H 29.5	<b>FLD16D</b> Fold 1600 Circular Table mm Dia 1600 H 750 inch Dia 63 H 29.5
<b>FLD16X8</b> Fold 1600 x 800 Table mm W 1600 D 800 H 750 inch W 63 D 31.5 H 29.5	<b>FLD18X8</b> Fold 1800 x 800 Table mm W 1800 D 800 H 750 inch W 71 D 31.5 H 29.5	<b>FLD20X9</b> Fold 2000 x 900 Table mm W 2000 D 900 H 750 inch W 79 D 35.5 H 29.5
<b>FLD22X9</b> Fold 2200 x 900 Table mm W 2200 D 900 H 750 inch W 87 D 35.5 H 29.5	<b>FLD24X10</b> Fold 2400 x 1000 Table mm W 2400 D 1000 H 750 inch W 94.5 D 39 H 29.5	<b>FLD24X12</b> Fold 2400 x 1200 Table mm W 2400 D 1200 H 750 inch W 94.5 D 47.5 H 29.5
<b>FLD28</b> Fold 6 Leg Table 2800 mm W 2800 D 1200 H 750 inch W 110 D 47.5 H 29.5	<b>FLD32</b> Fold 6 Leg Table 3200 mm W 3200 D 1200 H 750 inch W 126 D 47.5 H 29.5	
<b>FLD16BH</b> Fold Bar Height Table 1600 mm W 1600 D 800 H 1000 inch W 63 D 31.5 H 39	<b>FLD18BH</b> Fold Bar Height Table 1800 mm W 1800 D 800 H 1000 inch W 71 D 31.5 H 39	<b>FLD20BH</b> Fold Bar Height Table 2000 mm W 2000 D 900 H 1000 inch W 79 D 35.5 H 39
<b>FLD22BH</b> Fold Bar Height Table 2200 mm W 2200 D 900 H 1000 inch W 87 D 35.5 H 39	<b>FLD28BH</b> Fold 6 Leg Bar Height Table 2800 mm W 2800 D 1200 H 1000 inch W 110 D 47.5 H 39	<b>FLD32BH</b> Fold 6 Leg Bar Height Table 3200 mm W 3200 D 1200 H 1000 inch W 126 D 47.5 H 39

### Base Finishes

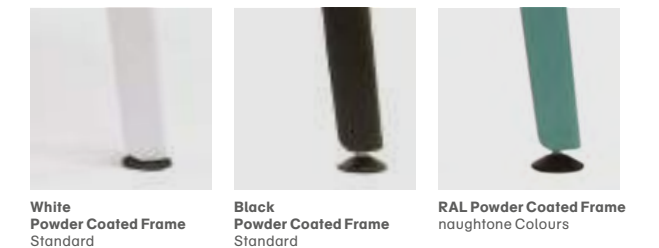

### Top Options



### Power and Data Options

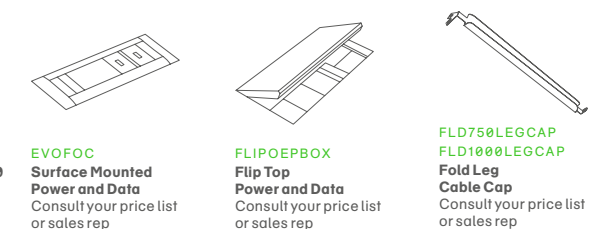

### naughtone RAL Colours





frog  
Table

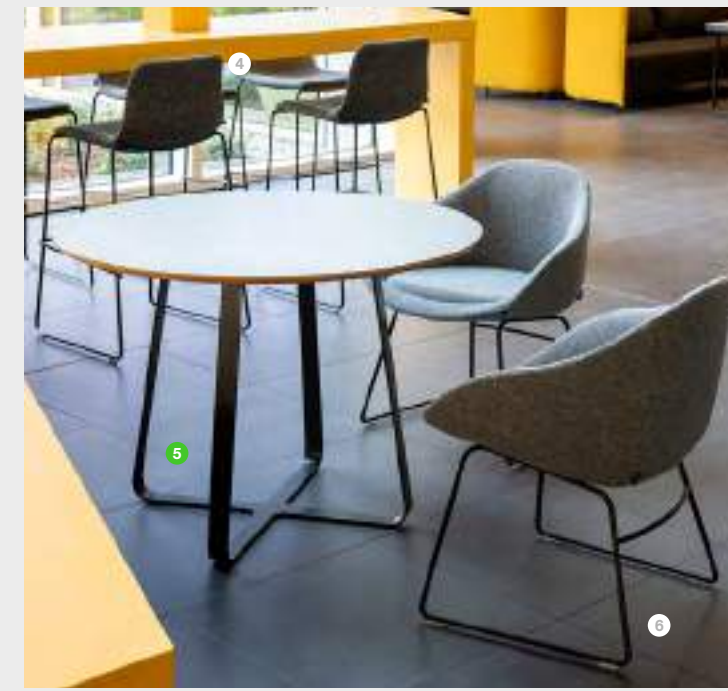

**About Frog**

Frog is a classically elegant yet functional table that is visually light and uncluttered. The base pays careful attention to the scale of the material and repetition of bends, making it a great choice for the workplace, restaurants or in the home.

**Compliance**

- SCS Indoor Advantage™ Gold Certificate
- naughtone is FSC® certified
- naughtone is FISP and ISO14001 certified
- Our tables are designed to meet or exceed all EN performance requirements per BS EN 15372:2016

**Sizes** All dimensions quoted are rounded to the nearest 5mm or nearest 1/2 inch



**FRG650D**  
Frog Table 650 Circular  
mm Dia 650 H 750  
inch Dia 25.5 H 29.5



**FRG650S**  
Frog Table 650 Square  
mm W 650 D 650 H 750  
inch W 25.5 D 25.5 H 29.5



**FRG850D**  
Frog Table 850 Circular  
mm Dia 850 H 750  
inch Dia 33.5 H 29.5



**FRG850S**  
Frog Table 850 Square  
mm W 850 D 850 H 750  
inch W 33.5 D 33.5 H 29.5



**FRG1050D**  
Frog Table 1050 Circular  
mm Dia 1050 H 750  
inch Dia 41.5 H 29.5

**Base Finishes**



White / Black Powder Coated Frame Standard



RAL Powder Coated Frame naughtone Colours

**Top Options**



White / Black MFMDf edge banded



White / Black MFMDf with reverse chamfer, polished MDF edge



Forbo Lino with reverse chamfer edge 8 colours available



Oak Veneer with reverse chamfer, polished MDF edge



Walnut Veneer with reverse chamfer, polished MDF edge

# dalby

## Wooden Leg Coffee and Cafe Table



### About Dalby

As your newest old friend, the Dalby table will effortlessly inject warmth and quality into an interior. Dalby provides a practical and robust surface making it ideal for the hospitality industry, or the home. Built from solid materials, Dalby will last as long as it's timeless aesthetic endures.

### Compliance

- SCS Indoor Advantage™ Gold Certificate
- naughtone is FSC® certified
- naughtone is FISP and ISO14001 certified
- Our tables are designed to meet or exceed all EN performance requirements per BS EN 15372:2016

### Sizes

All dimensions quoted are rounded to the nearest 5mm or nearest 1/2 inch



**DAL650DL**  
Dalby 650 Circular Coffee Table  
mm Dia 650 H 350  
inch Dia 25.5 H 14



**DAL650SL**  
Dalby 650 Square Coffee Table  
mm W 650 D 650 H 350  
inch W 25.5 D 25.5 H 14



**DAL850DL**  
Dalby 850 Circular Coffee Table  
mm Dia 850 H 350  
inch Dia 33.5 H 14



**DAL850SL**  
Dalby 850 Square Coffee Table  
mm W 850 D 850 H 350  
inch W 33.5 D 33.5 H 14



**DAL11X55L**  
Dalby Rectangular Coffee Table  
mm W 1100 D 550 H 350  
inch W 43.5 D 21.5 H 14



**DAL350D**  
Dalby 350 Circular Side Table  
mm Dia 350 H 550  
inch Dia 14 H 21.5



**DAL350S**  
Dalby 350 Square Side Table  
mm W 350 D 350 H 550  
inch W 14 D 14 H 21.5



**DAL650S**  
Dalby 650 Square Cafe Table  
mm W 650 D 650 H 750  
inch W 25.5 D 25.5 H 29.5



**DAL850D**  
Dalby 850 Circular Cafe Table  
mm Dia 850 H 750  
inch Dia 33.5 H 29.5



**DAL850S**  
Dalby 850 Square Cafe Table  
mm W 850 D 850 H 750  
inch W 33.5 D 33.5 H 29.5

### Base Finishes



**Solid Oak**  
Matt lacquered

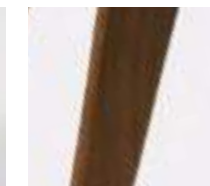

**Walnut**  
Matt lacquered

### Top Options



**White / Black MFMDF**  
edge banded



**White / Black MFMDF**  
with reverse chamfer,  
polished MDF edge



**Forbo Lino**  
with reverse chamfer edge  
8 colours available



**Oak Veneer**  
with reverse chamfer,  
polished MDF edge



**Walnut Veneer**  
with reverse chamfer,  
polished MDF edge



**White Carrara Marble**  
with reverse chamfer  
Coffee tables only

# dalby

## Wooden Leg Table



### About Dalby

















As your newest old friend, the Dalby table will effortlessly inject warmth and quality into an interior. Dalby provides a practical and robust surface making it ideal for the hospitality industry, or the home. Built from solid materials, Dalby will last as long as it's timeless aesthetic endures.

### Compliance

- SCS Indoor Advantage™ Gold Certificate
- naughtone is FSC® certified
- naughtone is FISP and ISO14001 certified
- Our tables are designed to meet or exceed all EN performance requirements per BS EN 15372:2016

### Sizes

All dimensions quoted are rounded to the nearest 5mm or nearest 1/2 inch

 <p><b>DAL12DIA</b> Dalby 1200 Circular Table mm Dia 1200 D 750 inch Dia 47.5 H 29.5</p>	 <p><b>DAL14DIA</b> Dalby 1400 Circular Table mm Dia 1400 D 750 inch Dia 55 H 29.5</p>	 <p><b>DAL16DIA</b> Dalby 1600 Circular Table mm Dia 1600 D 750 inch Dia 63 H 29.5</p>
 <p><b>DAL16X8</b> Dalby 1600x800 Table mm W 1600 D 800 H 750 inch W 63 D 31.5 H 29.5</p>	 <p><b>DAL18X8</b> Dalby 1800x800 Table mm W 1800 D 800 H 750 inch W 71 D 31.5 H 29.5</p>	 <p><b>DAL20X9</b> Dalby 2000x900 Table mm W 2000 D 900 H 750 inch W 79 D 35.5 H 29.5</p>
 <p><b>DAL22X9</b> Dalby 2200x900 Table mm W 2200 D 900 H 750 inch W 87 D 35.5 H 29.5</p>	 <p><b>DAL24X10</b> Dalby 2400x1000 Table mm W 2400 D 1000 H 750 inch W 94.5 D 39.5 H 29.5</p>	 <p><b>DAL24X12</b> Dalby 2400x1200 Table mm W 2400 D 1200 H 750 inch W 94.5 D 47.5 H 29.5</p>
	 <p><b>DAL28X12</b> Dalby 6 Leg Table 2800 mm W 2800 D 1200 H 750 inch W 110 D 47.5 H 29.5</p>	 <p><b>DAL32X12</b> Dalby 6 Leg Table 3200 mm W 3200 D 1200 H 750 inch W 126 D 47.5 H 29.5</p>
 <p><b>DAL16BH</b> Dalby Bar Height Table 1600 mm W 1600 D 800 H 1000 inch W 63 D 31.5 H 39</p>	 <p><b>DAL18BH</b> Dalby Bar Height Table 1800 mm W 1800 D 800 H 1000 inch W 71 D 31.5 H 39</p>	 <p><b>DAL20BH</b> Dalby Bar Height Table 2000 mm W 2000 D 900 H 1000 inch W 79 D 35.5 H 39</p>
 <p><b>DAL22BH</b> Dalby Bar Height Table 2200 mm W 2200 D 900 H 1000 inch W 87 D 35.5 H 39</p>	 <p><b>DAL28BH</b> Dalby 6 Leg Bar Height Table 2800 mm W 2800 D 1200 H 1000 inch W 110 D 47.5 H 39</p>	 <p><b>DAL32BH</b> Dalby 6 Leg Bar Height Table 3200 mm W 3200 D 1200 H 1000 inch W 126 D 47.5 H 39</p>

### Base Finishes



Solid Oak  
Matt lacquered

Walnut  
Matt lacquered

### Top Options



White / Black MFMDf  
edge banded

White / Black MFMDf  
with reverse chamfer,  
polished MDF edge

Forbo Lino  
with reverse chamfer edge  
8 colours available



Oak Veneer  
with reverse chamfer,  
polished MDF edge

Walnut Veneer  
with reverse chamfer,  
polished MDF edge

### Power and Data Options

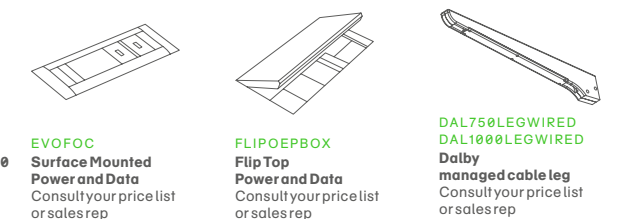

EVOFOC  
Surface Mounted  
Power and Data  
Consult your price list  
or sales rep

FLIPOEPBOX  
Flip Top  
Power and Data  
Consult your price list  
or sales rep

DAL750LEGWIRED  
DAL1000LEGWIRED  
Dalby  
managed cable leg  
Consult your price list  
or sales rep



**About Ped**

A simple thing done well, the Ped table is versatile and unobtrusive with its soft square shaped base. Robust and strong, Ped performs in most environments from hospitality to the workplace.

**Compliance**

- SCS Indoor Advantage™ Gold Certificate
- naughtone is FSC® certified
- naughtone is FISP and ISO14001 certified
- Our tables are designed to meet or exceed all EN performance requirements per BS EN 15372:2016

**Sizes** All dimensions quoted are rounded to the nearest 5mm or nearest 1/2 inch

 <b>PED650DL</b> Ped 650 Circular Coffee Table mm Dia 650 H 450 inch Dia 25.5 H 17.5	 <b>PED650SL</b> Ped 650 Square Coffee Table mm W 650 D 650 H 450 inch W 25.5 D 25.5 H 17.5	
 <b>PED650D</b> Ped 650 Circular Table mm Dia 650 H 750 inch Dia 25.5 H 29.5	 <b>PED650S</b> Ped 650 Square Table mm W 650 D 650 H 750 inch W 25.5 D 25.5 H 29.5	
 <b>PED850D</b> Ped 850 Circular Table mm Dia 850 H 750 inch Dia 33.5 H 29.5	 <b>PED850S</b> Ped 850 Square Table mm W 850 D 850 H 750 inch W 33.5 D 33.5 H 29.5	 <b>PED1050D</b> Ped 1050 Circular Table mm Dia 1050 H 750 inch Dia 41.5 H 29.5
 <b>PED650DH</b> Ped 650 Circular Poseur Table mm Dia 650 H 1000 inch Dia 25.5 H 39.5	 <b>PED650SH</b> Ped 650 Square Poseur Table mm W 650 D 650 H 1000 inch W 25.5 D 25.5 H 39.5	

**Base Finishes**

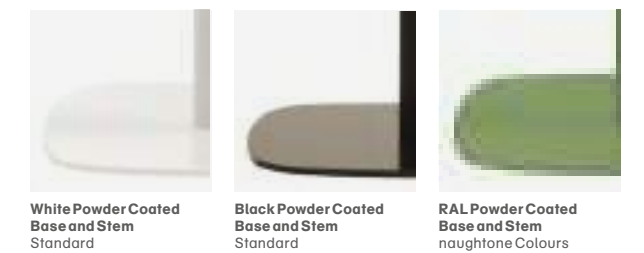

**Top Options**





# megaped

## Table



### About Megaped

With a pared down design and robust construction, the Megaped table supports large table tops. Megaped is perfectly suited for workplace meetings or large functions. The minimalistic soft square shaped base and hollow stem allows for maximum leg space and can be fitted with power and data.

### Compliance

- SCS Indoor Advantage™ Gold Certificate
- naughtone is FSC® certified
- naughtone is FISP and ISO14001 certified
- Our tables are designed to meet or exceed all EN performance requirements per BS EN 15372:2016

### Sizes

All dimensions quoted are rounded to the nearest 5mm or nearest 1/2 inch

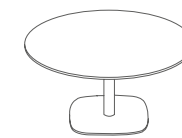

**MP105D**  
Megaped 1050 Circular Table  
mm  
Dia 1050 H 750  
inch  
Dia 41.5 H 29.5

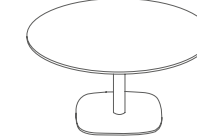

**MP12D**  
Megaped 1200 Circular Table  
mm  
Dia 1200 H 750  
inch  
Dia 47 H 29.5

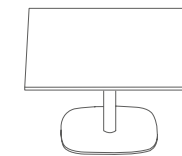

**MP115S**  
Megaped 1150 Square Table  
mm  
W 1150 D 1150 H 750  
inch  
W 45.5 D 45.5 H 29.5

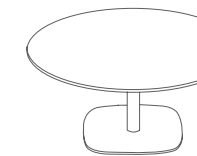

**MP15D**  
Megaped 1500 Circular Table  
mm  
Dia 1500 H 750  
inch  
Dia 59 H 29.5

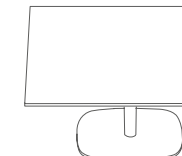

**MP150S**  
Megaped 1500 Square Table  
mm  
W 1500 D 1500 H 750  
inch  
W 59 D 59 H 29.5



**MP20D**  
Megaped 2000 Circular Table  
mm  
Dia 2000 H 750  
inch  
Dia 79 H 29.5

### Base Finishes



White Powder Coated  
Base and Stem  
Standard



Black Powder Coated  
Base and Stem  
Standard

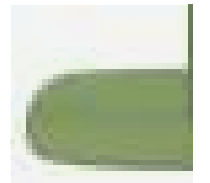

RAL Powder Coated  
Base and Stem  
naughtone Colours

### Top Options



White / Black MFMDf  
edge banded



White / Black MFMDf  
with reverse chamfer,  
polished MDF edge



Forbo Lino  
with reverse chamfer edge  
8 colours available



Oak Veneer  
with reverse chamfer,  
polished MDF edge



Walnut Veneer  
with reverse chamfer,  
polished MDF edge

### Power and Data Options



**EVOPORT**  
Port Unit  
Power and Data  
Consult your price list  
or sales rep



**OEPIX**  
Pixel  
Power and Data  
Consult your price list  
or sales rep

### naughtone RAL Colours



# ali <sup>New</sup> Table



## About Ali

Ali is the most recent addition to naughtone's range of coffee, café and poseur tables, working particularly well in the hospitality and education sectors. Ali has a robust die cast aluminium base that is lightweight and perfectly complements our range of 4 star based chairs, within an abundance of environments.

## Compliance

- SCS Indoor Advantage™ Gold Certificate
- naughtone is FSC® certified
- naughtone is FISP and ISO14001 certified
- Our tables are designed to meet or exceed all EN performance requirements per BS EN 15372:2016

## Sizes

All dimensions quoted are rounded to the nearest 5mm or nearest 1/2 inch



**ALI650DL**  
Ali 650 Circular Coffee Table  
mm Dia 650 H 450  
inch Dia 25.5 H 17.5



**ALI650SL**  
Ali 650 Square Coffee Table  
mm W 650 D 650 H 450  
inch W 25.5 D 25.5 H 17.5



**ALI850DL**  
Ali 850 Circular Coffee Table  
mm Dia 850 H 450  
inch Dia 33.5 H 17.5



**ALI850SL**  
Ali 850 Square Coffee Table  
mm W 850 D 850 H 450  
inch W 33.5 D 33.5 H 17.5



**ALI650D**  
Ali 650 Circular Cafe Table  
mm Dia 650 H 750  
inch Dia 25.5 H 29.5



**ALI650S**  
Ali 650 Square Cafe Table  
mm W 650 D 650 H 750  
inch W 25.5 D 25.5 H 29.5



**ALI850D**  
Ali 850 Circular Cafe Table  
mm Dia 850 H 750  
inch Dia 33.5 H 29.5



**ALI850S**  
Ali 850 Square Cafe Table  
mm W 850 D 850 H 750  
inch W 33.5 D 33.5 H 29.5



**ALI650DH**  
Ali 650 Circular Poseur Height Table  
mm Dia 650 H 1000  
inch Dia 25.5 H 39.5



**ALI650SH**  
Ali 650 Square Poseur Height Table  
mm W 650 D 650 H 1000  
inch W 25.5 D 25.5 H 39.5



**ALI850DH**  
Ali 850 Circular Poseur Height Table  
mm Dia 850 H 1000  
inch Dia 33.5 H 39.5

## Top Options



**White / Black MFMDF**  
edge banded



**White / Black MFMDF**  
with reverse chamfer,  
polished MDF edge



**Forbo Lino**  
with reverse chamfer edge  
8 colours available



**Oak Veneer**  
with reverse chamfer,  
polished MDF edge



**Walnut Veneer**  
with reverse chamfer,  
polished MDF edge

## Base Finishes



**White Powder Coated**  
Base and Stem  
Standard



**Black Powder Coated**  
Base and Stem  
Standard



**RAL Powder Coated**  
Base and Stem  
naughtone Colours



# knot

Table



## About Knot

Taking its name from the cartoon like aesthetic of the knotted tube stem, Knot is the perfect height and scale to work with a multitude of seating within the workplace, education, hospitality and domestic environments.

## Compliance

- SCS Indoor Advantage™ Gold Certificate
- naughtone is FSC® certified
- naughtone is FISP and ISO14001 certified
- Our tables are designed to meet or exceed all EN performance requirements per BS EN 15372:2016

## Sizes

All dimensions quoted are rounded to the nearest 5mm or nearest 1/2 inch



**KNO50X40**  
Knot Rectangular Table  
mm  
W 400 D 500 H 650  
inch  
W 15.5 D 19.5 H 25.5



**KNO550D**  
Knot 550 Circular Table  
mm  
Dia 550 H 650  
inch  
Dia 21.5 H 25.5

## Top Options



**White / Black MFMDf**  
edge banded



**White / Black MFMDf**  
with reverse chamfer,  
polished MDF edge



**Forbo Lino**  
with reverse chamfer edge  
8 colours available



**Oak Veneer**  
with reverse chamfer,  
polished MDF edge



**Walnut Veneer**  
with reverse chamfer,  
polished MDF edge

## Base Finishes

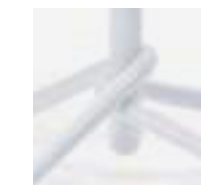

**White Powder Coated**  
Base  
Standard

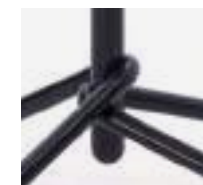

**Black Powder Coated**  
Base  
Standard



**RAL Powder Coated**  
Base  
naughtone Colours

# riley

Table

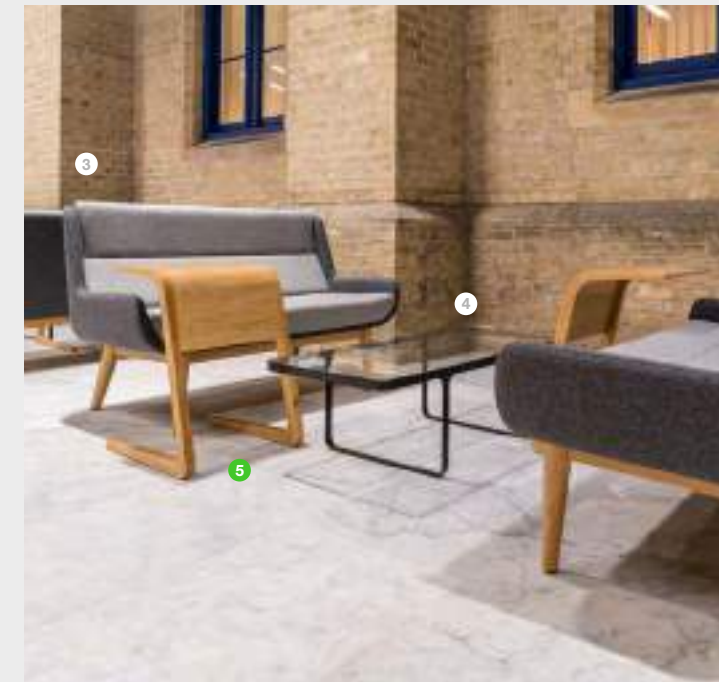

### About Riley

Riley is a staple in the naughtone portfolio; a beautifully crafted, solid wood pull up table that is a sleek and functional addition to any environment. The wooden table is designed to slide perfectly over benches, or sofa and arm chairs.

### Compliance

- SCS Indoor Advantage™ Gold Certificate
- naughtone is FSC® certified
- naughtone is FISP and ISO14001 certified
- Our tables are designed to meet or exceed all EN performance requirements per BS EN 15372:2016

**Size** All dimensions quoted are rounded to the nearest 5mm or nearest 1/2 inch

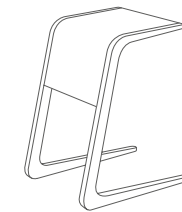

RILEY  
 Riley Table  
 mm  
 W 450 D 550 H 650  
 inch  
 W 17.5 D 21.5 H 25.5

### Finishes



Oak

Walnut

# shard

Coatstand



### Compliance

- SCS Indoor Advantage™ Gold Certificate
- naughtone is FISP and ISO14001 certified

### Size

All dimensions quoted are rounded to the nearest 5mm or nearest 1/2 inch

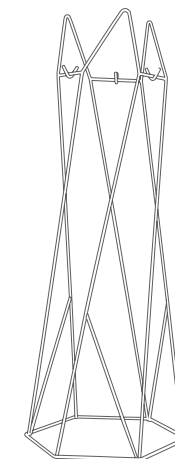

SHARDCOMP  
 Shard Coatstand  
 mm  
 W630 D550 H1630  
 inch  
 W25 D21.5 H64.5

### Finishes



White Powder Coated SteelFrame Standard

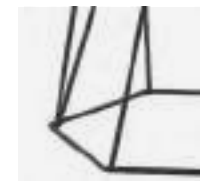

Black Powder Coated SteelFrame Standard



RAL Powder Coated SteelFrame naughtone Colours

# sideboard

Storage



## About Sideboard

Sideboard works effortlessly as a storage unit, whilst sitting un-noticed in a space. Equally, Sideboard holds its colour very well and can be a great way to add a splash of colour to an interior.

## Compliance

- SCS Indoor Advantage™ Gold Certificate
- naughtone is FSC® certified
- naughtone is FISP and ISO14001 certified
- Our storage units are designed to meet or exceed all EN performance requirements per BS EN 16121:2013

## Size

All dimensions quoted are rounded to the nearest 5mm or nearest 1/2 inch

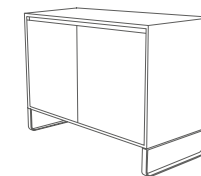

**SB12**  
Sideboard 1200  
mm  
W 1200 D 500 H 750  
inch  
W 47 D 19.5 H 29.5

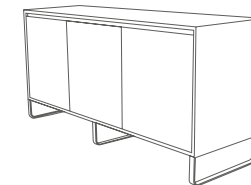

**SB16**  
Sideboard 1600  
mm  
W 1600 D 500 H 750  
inch  
W 63 D 19.5 H 29.5

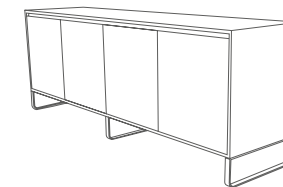

**SB20**  
Sideboard 2000  
mm  
W 2000 D 500 H 750  
inch  
W 79 D 19.5 H 29.5

## Other Options



AV Cut-Outs

## Finish Options



Lacquered MDF  
in naughtone RAL Colours



Walnut Veneer



Oak Veneer

## Top Options



Back Painted Glass



Marble



Walnut / Oak Veneer

## Base Options / Finishes



White Powder Coated  
Sled Base  
Standard



Black Powder Coated  
Sled Base  
Standard



RAL Powder Coated  
Sled Base  
naughtone Colours

## naughtone RAL Colours



# softbox

Storage



## About Softbox

Softbox is an upholstered storage unit so can be ultimately customised to match other products within an interior. The upholstery brings acoustic benefits to a storage unit and can also be used to divide space as the unit is upholstered all the way around.

## Compliance

- SCS Indoor Advantage™ Gold Certificate
- naughtone is FSC® certified
- naughtone is FISP and ISO14001 certified
- Our storage units are designed to meet or exceed all EN performance requirements per BS EN 16121:2013

## Sizes

All dimensions quoted are rounded to the nearest 5mm or nearest 1/2 inch

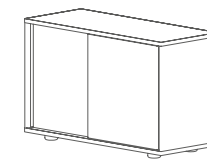

**SBX12**  
Softbox 1200  
mm  
W 1200 D 500 H 750  
inch  
W 47.5 D 20 H 29.5

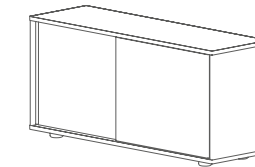

**SBX16**  
Softbox 1600  
mm  
W 1600 D 500 H 750  
inch  
W 63 D 20 H 29.5

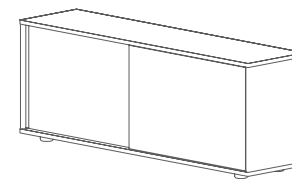

**SBX20**  
Softbox 2000  
mm  
W 2000 D 500 H 750  
inch  
W 79 D 20 H 29.5

## Top Options



**White / Black MFMDF**  
Matching edge band



**Oak or Walnut veneer**  
Matching edge band



**Forbo Lino**  
White / Oak / Walnut  
edge band



pollen  
Stool

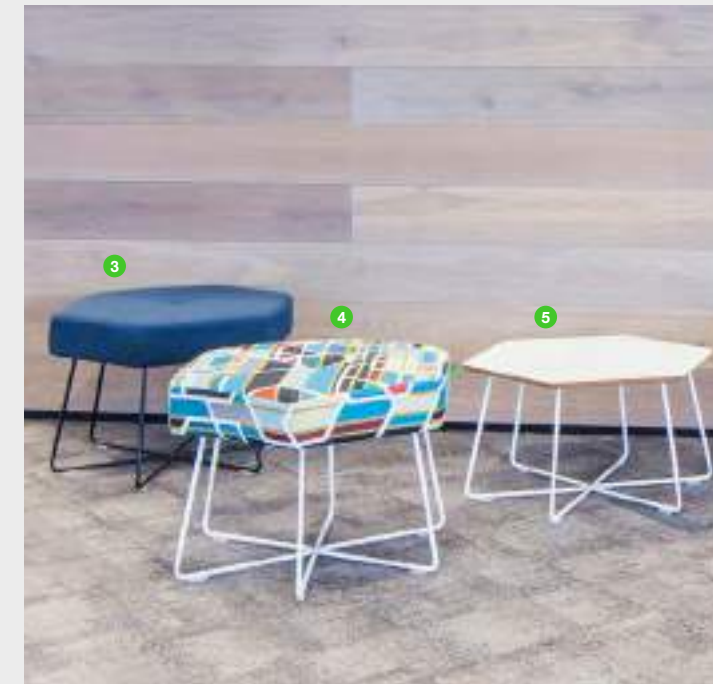

**About Pollen**

The hexagon is a naturally repeating and pleasing shape that lends itself to being used in small clusters, straight lines or tucked into corners. Pollen is a truly dynamic seating and table system.

**Compliance**

- SCS Indoor Advantage™ Gold Certificate
- naughtone is FSC® certified
- naughtone is FISP and ISO14001 certified
- Our stools are designed to meet or exceed all EN performance requirements per **BS EN 16139:2013**
- Our tables are designed to meet or exceed all EN performance requirements per **BS EN 15372:2016**

**Sizes** All dimensions quoted are rounded to the nearest 5mm or nearest 1/2 inch

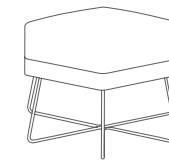

**POLST**  
Pollen Stool  
mm  
W685 D600 H450 Seat 450  
inch  
W27 D23.5 H17.5 Seat 17.5

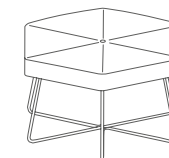

**POLSTBT**  
Pollen Buttoned Stool  
mm  
W685 D600 H450 Seat 450  
inch  
W27 D23.5 H17.5 Seat 17.5



**POLTAB**  
Pollen Table  
mm  
W685 D600 H350  
inch  
W27 D23.5 H14

**Base Finishes**



White / Black Powder Coated Base Standard



RAL Powder Coated Base naughtone Colours



Chrome Base

**Table Top Options**



White / Black MFMD with reverse chamfer, polished MDF edge



Forbo Lino with reverse chamfer edge 8 colours available



Oak Veneer with reverse chamfer, polished MDF edge



Walnut Veneer with reverse chamfer, polished MDF edge

# pinch

## Stool

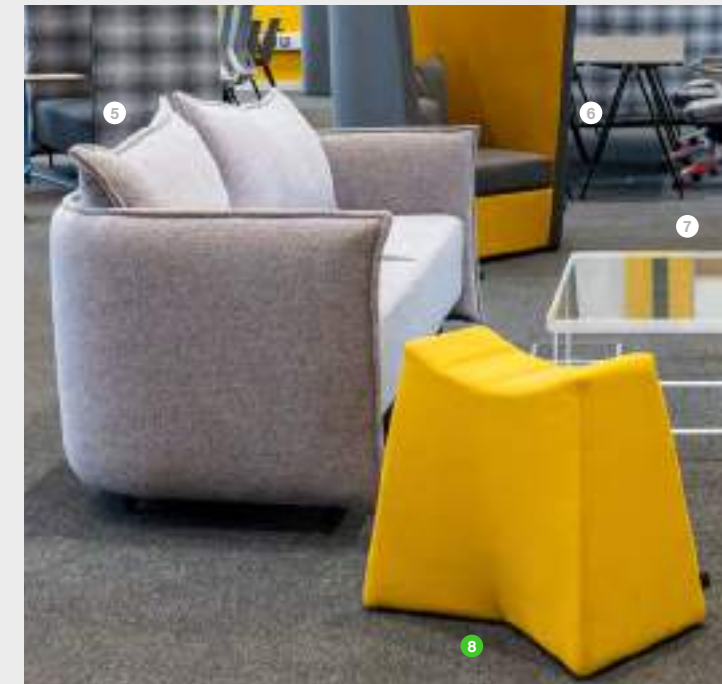

### About Pinch

Pinch is truly versatile, offering a comfortable seat whether used at a table, mingled with soft seating or scattered in a space. Pinch works brilliantly as functional and occasional seating, in public, educational or hospitality spaces.

### Compliance

- SCS Indoor Advantage™ Gold Certificate
- naughtone is FSC® certified
- naughtone is FISP and ISO14001 certified
- Our stools are designed to meet or exceed all EN performance requirements per BS EN 16139:2013

### Sizes

All dimensions quoted are rounded to the nearest 5mm or nearest 1/2 inch

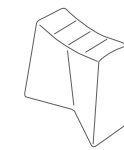

**PINST**  
Pinch Stool  
mm  
W 550 D 350 H 500 Seat 450  
inch  
W 21.5 D 14 H 19.5 Seat 17.5

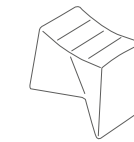

**PINLO**  
Pinch Low Stool  
mm  
W 600 D 450 H 400 Seat 350  
inch  
W 23.5 D 17.5 H 16 Seat 14

### Other Options

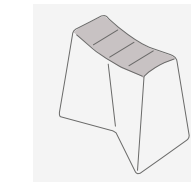

**Two Tone**  
Seat Top / All Sides

# lasso

New

## Seating



### About Lasso

Lasso is a collaborative seating and table system that can be easily moved to create clusters around the three seat stool. The Lasso seating range is ideally suited to project work within open spaces.



Available to order August 2019

### Compliance

- SCS Indoor Advantage™ Gold Certificate
- naughtone is FSC® certified
- naughtone is FISP and ISO14001 certified

### Sizes

All dimensions quoted are rounded to the nearest 5mm or nearest 1/2 inch



**LASST**  
Lasso Stool  
mm  
W 510 D 510 H 485 Seat 485  
inch  
W 20 D 20 H 19 Seat 19

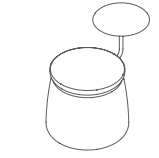

**LASSTTAB**  
Lasso Stool and Table  
mm  
W 510 D 725 H 705 Seat 485  
inch  
W 20 D 28.5 H 28 Seat 19

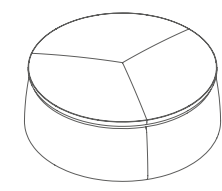

**LAS3S**  
Lasso 3 Seat Stool  
mm  
W 1210 D 1210 H 500 Seat 485  
inch  
W 47.5 D 47.5 H 19.5 Seat 19

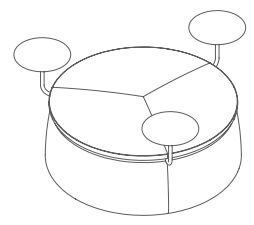

**LAS3STAB**  
Lasso 3 Seat Stool and Tables  
mm  
W 1425 D 1465 H 705 Seat 485  
inch  
W 56 D 57.5 H 28 Seat 19

### Table Options



**White / Black MFMD**  
with reverse chamfer,  
polished MDF edge



**Oak Veneer**  
with reverse chamfer,  
polished MDF edge



**Walnut Veneer**  
with reverse chamfer,  
polished MDF edge

### Ring / Tablet Ring Finishes



**White / Black**  
Ring / Tablet Arm  
Standard



**RAL Powder Coated**  
Ring / Tablet Arm  
naughtone Colours

### Other Options

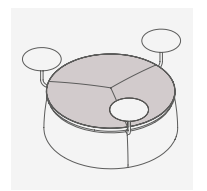

**Two Tone**  
Body / Seat Top



**Product Updates**  
View or download the latest product options and finishes from [www.naughtone.com/products](http://www.naughtone.com/products)





# construct

Low Stool and Barstool



## About Construct

The Construct range has an industrial aesthetic thanks to its folded steel frame and visible rivet construction. Paired with a simple solid wood top this stool really wears its construction method on its sleeve.

## Compliance

- SCS Indoor Advantage™ Gold Certificate
- naughtone is FSC® certified
- naughtone is FISP and ISO14001 certified
- Our stools are designed to meet or exceed all EN performance requirements per BS EN 16139:2013

## Sizes

All dimensions quoted are rounded to the nearest 5mm or nearest 1/2 inch

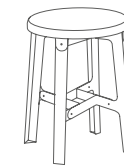

**CONLO**  
Construct Low Stool  
mm  
W 385 D 385 H 450  
inch  
W 15 D 15 H 17.5

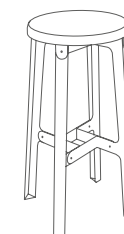

**CONCHS**  
Construct Counter Height Stool  
mm  
W 425 D 425 H 660  
inch  
W 16.5 D 16.5 H 26

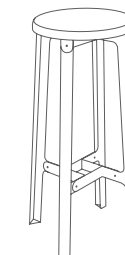

**CONBS**  
Construct Barstool  
mm  
W 425 D 425 H 760  
inch  
W 16.5 D 16.5 H 29.5

## Top Options



Solid Oak Seat



Solid Walnut Seat

## Base Finishes



White Powder Coated Standard



Black Powder Coated Standard



RAL Powder Coated naughtone Colours



# bounce

Chair



### About Bounce

Called the Bounce chair due to the independent movement of the seat and back, this flex provides a comfort not usually associated with steel and plywood chairs. Bounce is robust, elegant, lightweight and stackable; it is seen widely used in educational and hospitality settings.

Bounce stacks 8 on the ground and 14 on dedicated stacking trolley.

### Compliance

- SCS Indoor Advantage™ Gold Certificate
- naughtone is FSC® certified
- naughtone is FISP and ISO14001 certified
- Our chairs are designed to meet or exceed all EN performance requirements per BS EN 16139:2013

### Sizes

All dimensions quoted are rounded to the nearest 5mm or nearest 1/2 inch



**BOUCH**  
Bounce Chair  
mm W 555 D 550 H 752 Seat 452  
inch W 22 D 21.5 H 29.5 Seat 17.5

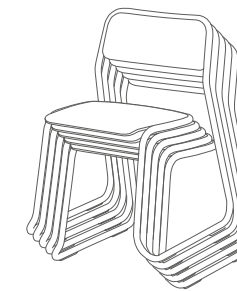

**Stacking Quantity**  
On Ground x 8  
On Stacking Trolley x 14

### Stacking Trolley

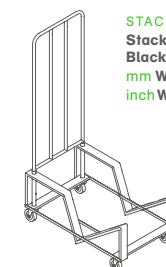

**STACKTRCOMP**  
Stacking Trolley  
Black  
mm W 1010 D 595 H 1690  
inch W 40 D 23.5 H 67

### Base Finishes



White Powder Coated Standard



Black Powder Coated Standard



RAL Powder Coated naughtone Colours

### Seat and Back Finishes



Oak Standard



Walnut

# polly

Chair / Barstool



## About Polly

Polly takes its name from the material of which the comfortable and ergonomic seat shell is made; polypropylene. Providing very little visual detail as possible, Polly has subtle edge details, a soft texture and just the right amount of flex, all combined to provide a tactile and satisfying sitting experience.

Polly stacks neatly on the ground and on a designated stacking trolley.

## Compliance

- SCS Indoor Advantage™ Gold Certificate
- naughtone is FSC® certified
- naughtone is FISP and ISO14001 certified
- Our chairs are designed to meet or exceed all EN performance requirements per BS EN 16139:2013

## Sizes

All dimensions quoted are rounded to the nearest 5mm or nearest 1/2 inch



**POLLYCHB4L**  
Polly Chair 4 Leg Base  
mm  
W 513 D 530 H 785 Seat 450  
inch  
W 20.5 D 21 H 31 Seat 17.5



**POLLYCHBSL**  
Polly Chair Sled Base  
mm  
W 524 D 530 H 785 Seat 450  
inch  
W 20.5 D 21 H 31 Seat 17.5



**POLLYCHBSB4L**  
Polly Counter Height Stool  
mm  
W 568 D 536 H 1005 Seat 650  
inch  
W 22.5 D 21 H 39.5 Seat 25.5



**POLLYBSB4L**  
Polly Barstool 4 Leg  
mm  
W 568 D 536 H 1105 Seat 735  
inch  
W 22.5 D 21 H 43.5 Seat 29



**POLLYCHSBSL**  
Polly Counter Height Stool on Sled Base  
mm  
W 565 D 565 H 1005 Seat 650  
inch  
W 22.5 D 22.5 H 39.5 Seat 25.5



**POLLYBSBSL**  
Polly Barstool on Sled base  
mm  
W 565 D 565 H 1100 Seat 735  
inch  
W 22.5 D 22.5 H 43.5 Seat 29

## Stacking Trolley Available for Chairs Only

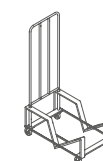

**STACKTRCOMP**  
Stacking Trolley Black  
mm  
W 1010 D 595 H 1690  
inch  
W 40 D 23.5 H 67

**Stacking Quantities**  
Polly Chair 4 Leg Base  
On Stacking Trolley x 20  
Polly Chair Sled Base  
On Stacking Trolley x 20  
Polly Chair with seatpad  
On Stacking Trolley x 12

## Base Finishes



Steel 4 Leg  
White / Black / Chrome



Steel 4 Leg  
RAL Powder Coated  
8 x Seat Shell Colours



Sled Base  
White / Black / Chrome



Sled Base  
RAL Powder Coated  
8 x Seat Shell Colours

## Other Options



Seatpad

## Seat Shell Colours 2019



# polly

4 Star / 5 Star

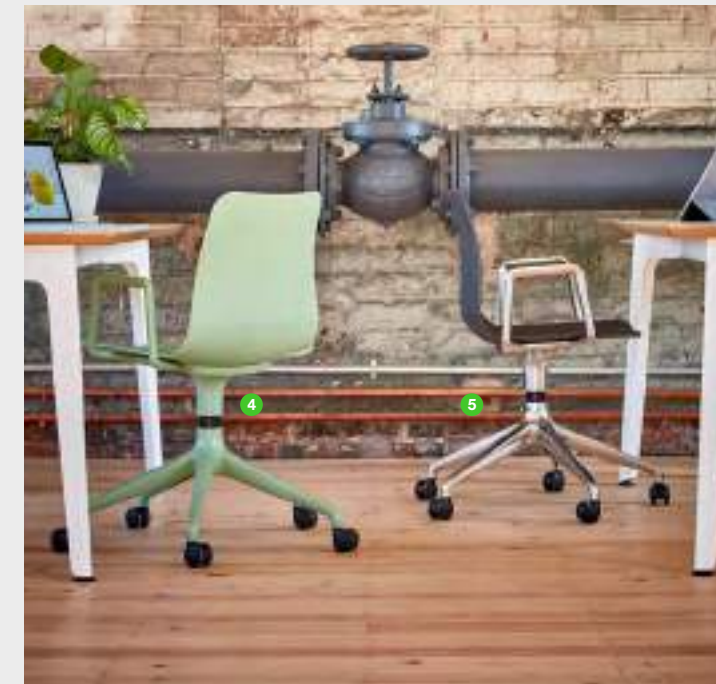

## About Polly

Polly takes its name from the material of which the comfortable and ergonomic seat shell is made; polypropylene. Providing very little visual detail as possible, Polly has subtle edge details, a soft texture and just the right amount of flex, all combined to provide a tactile and satisfying sitting experience.

## Compliance

- SCS Indoor Advantage™ Gold Certificate
- naughtone is FSC® certified
- naughtone is FISP and ISO14001 certified
- Our chairs are designed to meet or exceed all EN performance requirements per BS EN 16139:2013

## Sizes

All dimensions quoted are rounded to the nearest 5mm or nearest 1/2 inch

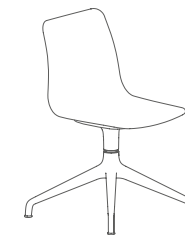

**POLLYCH4S**  
Polly Chair  
4 Star Base with Standard Glides  
mm  
W 500 D 530 H 785 Seat 450  
inch  
W 19.5 D 21 H 31 Seat 17.5

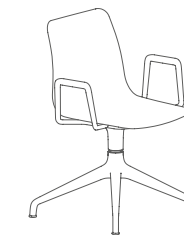

**POLLYACH4S**  
Polly Armchair  
4 Star Base with Standard Glides  
mm  
W 500 D 530 H 785 Seat 450  
inch  
W 19.5 D 21 H 31 Seat 17.5

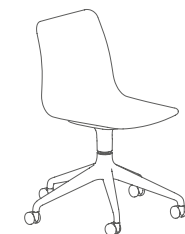

**POLLYCH5S**  
Polly Chair  
5 Star Base with Standard Castors  
mm  
W 635 D 530 H 785 Seat 450  
inch  
W 25 D 21 H 31 Seat 17.5

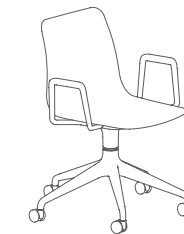

**POLLYACH5S**  
Polly Armchair  
5 Star Base with Standard Castors  
mm  
W 635 D 530 H 785 Seat 450  
inch  
W 25 D 21 H 31 Seat 17.5

## Base Finishes



4 Star Base  
White / Black / Polished



4 Star Base  
RAL Powder Coated  
naughtone Colours



5 Star Base  
White / Black / Polished

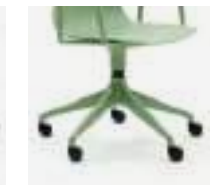

5 Star Base  
RAL Powder Coated  
naughtone Colours

## Other Options



5 Star Base  
Gas Lift mechanism



Seatpad

## Seat Shell Colours 2019

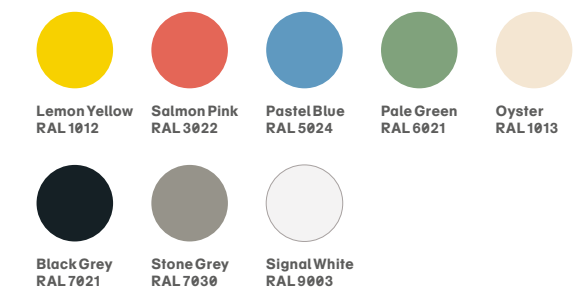

Lemon Yellow RAL 1012  
Salmon Pink RAL 3022  
Pastel Blue RAL 5024  
Pale Green RAL 6021  
Oyster RAL 1013  
Black Grey RAL 7021  
Stone Grey RAL 7030  
Signal White RAL 9003

# polly wood

## Chair



### About Polly Wood

Polly Wood is a direct reference to the honest materials used to create this product. Standing proud on a solid oak or walnut base, Polly Wood offers a very comfortable sit and an aesthetically pleasing shape, allowing it to blend effortlessly into any environment.

### Compliance

- SCS Indoor Advantage™ Gold Certificate
- naughtone is FSC® certified
- naughtone is FISP and ISO14001 certified
- Our chairs are designed to meet or exceed all EN performance requirements per BS EN 16139:2013

### Sizes

All dimensions quoted are rounded to the nearest 5mm or nearest 1/2 inch



**POLLYCHBWD**  
Polly Wood Chair  
mm  
W545 D 485 H805 Seat 450  
inch  
W21.5 D 19 H 32 Seat 17.5



**POLLYACHBWD**  
Polly Wood Armchair  
mm  
W545 D 485 H805 Seat 450  
inch  
W21.5 D 19 H 32 Seat 17.5



**POLLYCHSWD**  
Polly Wood Counter Height Stool  
mm  
W565 D 510 H1010 Seat 660  
inch  
W22.5 D 20 H 40 Seat 26



**POLLYBSWD**  
Polly Wood Barstool  
mm  
W575 D 555 H1085 Seat 750  
inch  
W22.5 D 22 H 42.5 Seat 29.5

### Base Finishes



Solid Oak Base



Solid Walnut Base

### Other Options



Seatpad

### Seat Shell Colours 2019

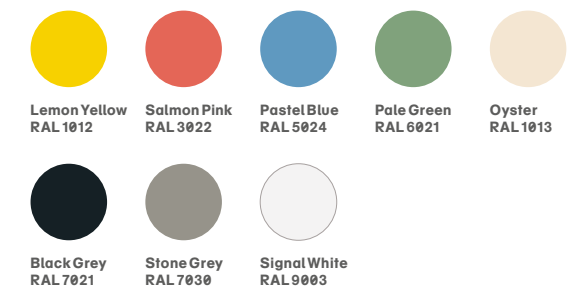

# viv wood

Chair / Lounge / Barstool



## About Viv Wood

As a simple and comfortable staple of the naughtone portfolio, the Viv Wood chair's slender shape combined with solid use of materials, is highlighted by its tight and skilful upholstery, making it a welcome addition to the home, meeting room or break out space.

## Compliance

- SCS Indoor Advantage™ Gold Certificate
- naughtone is FSC® certified
- naughtone is FISP and ISO14001 certified
- Our chairs are designed to meet or exceed all EN performance requirements per BS EN 16139:2013

## Sizes

All dimensions quoted are rounded to the nearest 5mm or nearest 1/2 inch



**VIVCHWD**  
Viv Wood Chair  
mm  
W515 D 560 H780 Seat 450  
inch  
W20.5 D 22 H30.5 Seat 17.5



**VIVCHSWD**  
Viv Wood Counter Height Stool  
mm  
W560 D 560 H910 Seat 660  
inch  
W22 D 22 H36 Seat 26



**VIVBSWD**  
Viv Wood Barstool Chair  
mm  
W560 D 560 H1000 Seat 750  
inch  
W22 D 22 H39.5 Seat 29.5



**VIVLOWD**  
Viv Wood Lounge Chair  
mm  
W595 D 650 H650 Seat 400  
inch  
W23.5 D 25.5 H25.5 Seat 16

## Base Finishes



Solid Oak base  
Standard

Solid Walnut base

# viv

Chair / Lounge / Barstool

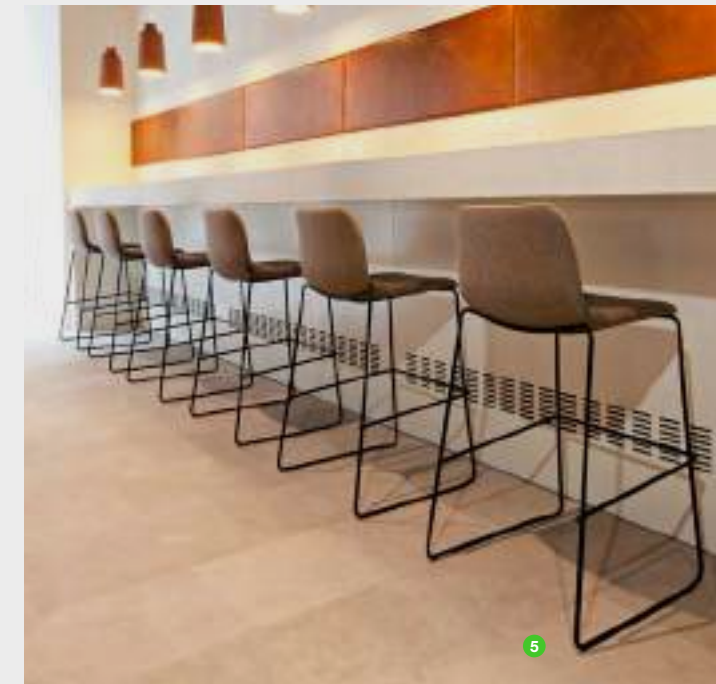

## About Viv

As a simple and comfortable staple of the naughtone portfolio, the Viv chair's slender shape is highlighted by its tight and skilful upholstery, making it a welcome addition to the home, meeting room or break out space.

Viv stacks neatly on the ground and on a designated stacking trolley.

## Compliance

- SCS Indoor Advantage™ Gold Certificate
- naughtone is FSC® certified
- naughtone is FISP and ISO14001 certified
- Our chairs are designed to meet or exceed all EN performance requirements per BS EN 16139:2013

## Sizes

All dimensions quoted are rounded to the nearest 5mm or nearest 1/2 inch



**VIVCHSL**  
Viv Chair  
mm  
W 515 D 560 H 780 Seat 450  
inch  
W 20.5 D 22 H 30.5 Seat 17.5



**VIVCHSSL**  
Viv Counter Height Stool  
mm  
W 560 D 560 H 910 Seat 660  
inch  
W 22 D 22 H 36 Seat 26



**VIVBSSL**  
Viv Barstool  
mm  
W 560 D 560 H 1000 Seat 750  
inch  
W 22 D 22 H 39.5 Seat 29.5



**VIVLOSL**  
Viv Lounge Chair  
mm  
W 595 D 650 H 650 Seat 400  
inch  
W 23.5 D 25.5 H 25.5 Seat 16

## Base Options



White / Black Powder Coated Base Standard



RAL Powder Coated Base naughtone Colours



Chrome Mild Steel Base

## Stacking Trolley Available for Chairs Only

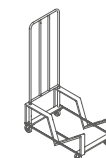

**STACKTRCOMP**  
Stacking Trolley Black  
mm  
W 1010 D 595 H 1690  
inch  
W 40 D 23.5 H 67

Stacking Quantities  
Viv Chair Sled Base  
On Stacking Trolley x 10

# viv

4 Star / 5 Star

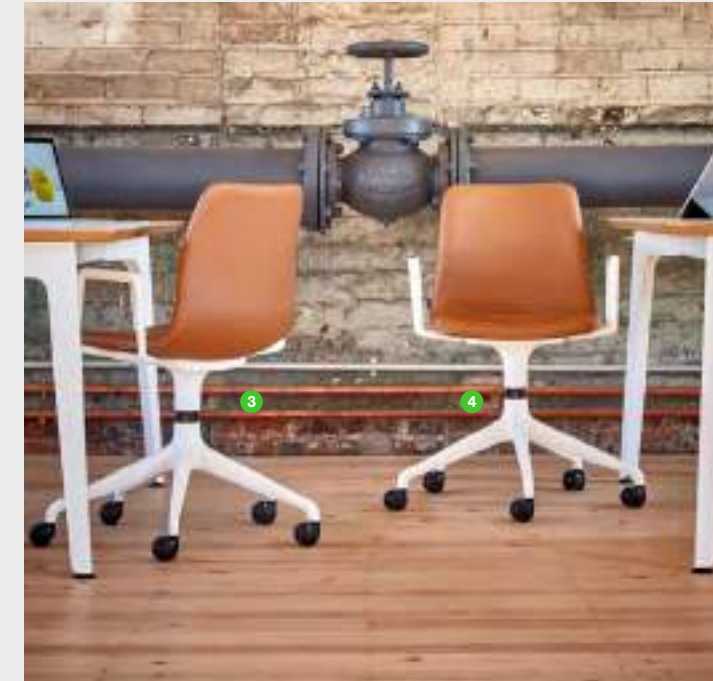

### About Viv

As a simple and comfortable staple of the naughtone portfolio, the Viv chair's slender shape is highlighted by its tight and skilful upholstery, making it a welcome addition to the home, meeting room or break out space.

### Compliance

- SCS Indoor Advantage™ Gold Certificate
- naughtone is FSC® certified
- naughtone is FISP and ISO14001 certified
- Our chairs are designed to meet or exceed all EN performance requirements per BS EN 16139:2013



### Sizes

All dimensions quoted are rounded to the nearest 5mm or nearest 1/2 inch

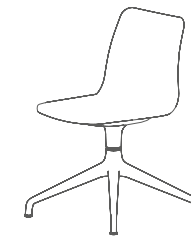

**VIVCH4S**  
Viv 4 Star Base  
mm  
W 500 D 530 H 785 Seat 450  
inch  
W 19.5 D 21 H 31 Seat 17.5

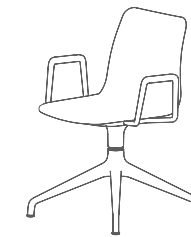

**VIVACH4S**  
Viv Armchair 4 Star Base  
mm  
W 500 D 530 H 785 Seat 450  
inch  
W 19.5 D 21 H 31 Seat 17.5



**VIVCH5S**  
Viv Chair 5 Star Base  
mm  
W 635 D 530 H 785 Seat 450  
inch  
W 25 D 21 H 31 Seat 17.5

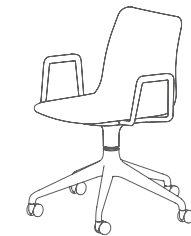

**VIVACH5S**  
Viv Armchair 5 Star Base  
mm  
W 635 D 530 H 785 Seat 450  
inch  
W 25 D 21 H 31 Seat 17.5

### Base Finishes



4 Star Base  
White / Black  
Standard



4 Star Base  
RAL Powder Coated  
naughtone Colours



4 Star Base  
Polished



5 Star Base  
White / Black  
Standard

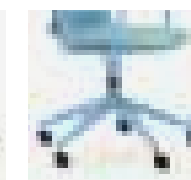

5 Star Base  
RAL Powder Coated  
naughtone Colours



5 Star Base  
Polished

### Other Options



5 Star Base  
Gas Lift mechanism



**viv** New

Highback / Highback Lounge



**About Viv Highback**

Available as highback or highback lounge, Viv Highback has a simple, broadly appealing form with a premium feel. The comfortable and generous upholstery and tilt mechanism offers superior comfort and launches the Viv range into a new realm.



Available to order August 2019 outside the U.S.



Available to order October 2019 for U.S.

**Compliance**

- SCS Indoor Advantage™ Gold Certificate
- naughtone is FSC® certified
- naughtone is FISP and ISO14001 certified

**Sizes** All dimensions quoted are rounded to the nearest 5mm or nearest 1/2 inch

New



**VIVHLO4S**  
Viv Highback Lounge Chair 4 Star Base  
mm W 620 D 640 H 930 Seat 400  
inch W 24.5 D 25 H 36.5 Seat 15.5

New



**VIVHALO4S**  
Viv Highback Lounge Armchair 4 Star Base  
mm W 620 D 640 H 930 Seat 400  
inch W 24.5 D 25 H 36.5 Seat 15.5

New



**VIVHCH4SL**  
Viv Highback Chair 4 Star Base with Gas Lift Mechanism  
mm W 525 D 640 H 1025-1125 Seat 450-550  
inch W 20.5 D 25 H 40-44 Seat 17.5-21.5

New



**VIVHACH4SL**  
Viv Highback Armchair 4 Star Base with Gas Lift Mechanism  
mm W 620 D 640 H 1025-1125 Seat 450-550  
inch W 24.5 D 25 H 40-44 Seat 17.5-21.5

New



**VIVHCH5SL**  
Viv Highback Chair 5 Star Base with Gas Lift Mechanism  
mm W 635 D 640 H 1025-1125 Seat 450-550  
inch W 25 D 25 H 40-44 Seat 17.5-21.5

New



**VIVHACH5SL**  
Viv Highback Armchair 5 Star Base with Gas Lift Mechanism  
mm W 635 D 640 H 1025-1125 Seat 450-550  
inch W 25 D 25 H 40-44 Seat 17.5-21.5

**Base Finishes**



Lounge 4 Star Base White / Black Standard



Lounge 4 Star Base RAL Powder Coated naughtone Colours



Lounge 4 Star Base Polished

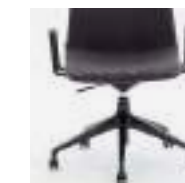

4 & 5 Star Base White / Black Standard



4 & 5 Star Base RAL Powder Coated naughtone Colours



4 & 5 Star Base Polished

# always

Chair

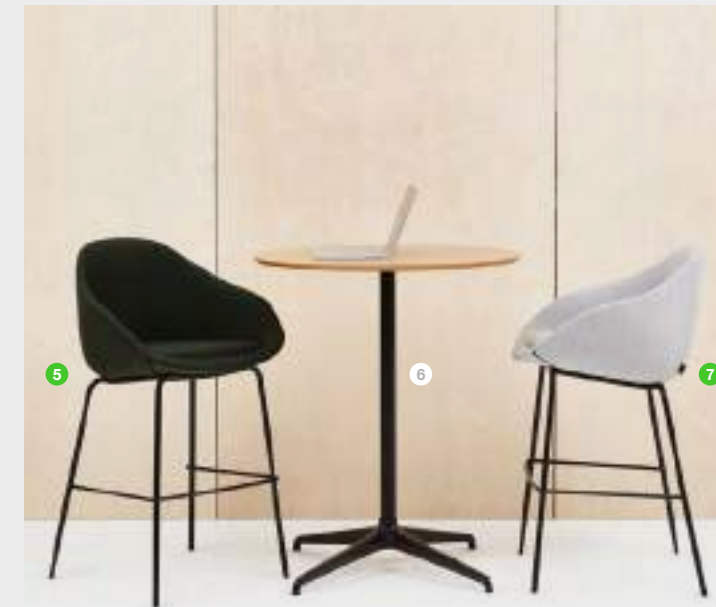

## About Always

Named Always because there is always a place for this chair. This chair offers positive back support with a comfortable enclosed feeling. Always has been designed with an organic form that complements any interior and looks great from every angle.

## Compliance

- SCS Indoor Advantage™ Gold Certificate
- naughtone is FSC® certified
- naughtone is FISP and ISO14001 certified
- Our chairs are designed to meet or exceed all EN performance requirements per BS EN 16139:2013

## Sizes

All dimensions quoted are rounded to the nearest 5mm or nearest 1/2 inch



**ALCHBST4**  
Always Chair  
on 4 Leg Base  
mm  
W625 D595 H780 Seat 470  
inch  
W24.5 D23.5 H30.5 Seat 18



**ALCHBSL**  
Always Chair  
on Sled Base  
mm  
W625 D595 H780 Seat 470  
inch  
W24.5 D23.5 H30.5 Seat 18



**ALCHBCL**  
Always Chair  
on Cantilever Base  
mm  
W625 D610 H780 Seat 470  
inch  
W24.5 D24 H30.5 Seat 18



**ALCHBWD**  
Always Chair  
on Wooden Base  
mm  
W625 D595 H780 Seat 470  
inch  
W24.5 D23.5 H30.5 Seat 18



**ALCHSST4**  
Always Counter Height Stool  
on 4 Leg Base  
mm  
W630 D600 H965 Seat 655  
inch  
W25 D23.5 H38 Seat 26

New



**ALBST4**  
Always Barstool  
on 4 Leg Base  
mm  
W630 D600 H1065 Seat 755  
inch  
W25 D23.5 H42 Seat 30

New

## Base Finishes



**Steel 4 Leg Base**  
White / Black / Chrome



**Steel 4 Leg Base**  
RAL Powder Coated  
naughtone Colours



Oak / Walnut Base



**Sled Base**  
White / Black / Chrome



**Sled Base**  
RAL Powder Coated  
naughtone Colours



**Cantilever**  
White / Black / Chrome



**Cantilever**  
RAL Powder Coated  
naughtone Colours

## Other Options



**Two Tone**  
Shell / Seatpad

## naughtone RAL Colours



# always

4 Star / 5 Star



2



1



3

4

## About Always

Named Always because there is always a place for this chair. This chair offers positive back support with a comfortable enclosed feeling. Always has been designed with an organic form that complements any interior and looks great from every angle.

## Compliance

- SCS Indoor Advantage™ Gold Certificate
- naughtone is FSC® certified
- naughtone is FISP and ISO14001 certified
- Our chairs are designed to meet or exceed all EN performance requirements per BS EN 16139:2013

## Sizes

All dimensions quoted are rounded to the nearest 5mm or nearest 1/2 inch



**ALCHB4S**  
Always Chair  
with 4 Star base  
mm  
W625 D595 H780 Seat 470  
inch  
W24.5 D23.5 H30.5 Seat 18

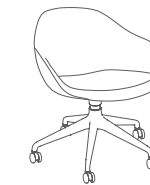

**ALCHB5S**  
Always Chair  
with 5 Star base  
mm  
W635 D595 H780 Seat 470  
inch  
W25 D23.5 H30.5 Seat 18

## Base Finishes



4 Star Base  
White / Black  
Standard



4 Star Base  
RAL Powder Coated  
naughtone Colours



4 Star Base  
Polished



5 Star Base  
White / Black  
Standard



5 Star Base  
RAL Powder Coated  
naughtone Colours



5 Star Base  
Polished

## Other Options



5 Star Base Gas Lift  
Optional



Two Tone  
Shell / Seatpad

# always lounge

## Chair

### About Always Lounge

An easy form for an easy chair; the Always Lounge hides its complexity well. A combination of shapes has created its relaxed form, allowing it to look great from all angles. The Always Lounge is completely customisable offering a wealth of upholstery options, working extremely well in hotels, the workplace, break out zones and public spaces.

### Compliance

- SCS Indoor Advantage™ Gold Certificate
- naughtone is FSC® certified
- naughtone is FISP and ISO14001 certified
- Our chairs are designed to meet or exceed all EN performance requirements per BS EN 16139:2013



### Sizes

All dimensions quoted are rounded to the nearest 5mm or nearest 1/2 inch



**ALLOBST4**  
Always Lounge  
4 Leg Base  
mm W 790 D 800 H 930 Seat 420  
inch W 31 D 31.5 H 36.5 Seat 16.5



**ALLOBSL**  
Always Lounge  
Sled Base  
mm W 790 D 800 H 930 Seat 420  
inch W 31 D 31.5 H 36.5 Seat 16.5



**ALLOB4S**  
Always Lounge  
4 Star Base  
mm W 790 D 800 H 930 Seat 420  
inch W 31 D 31.5 H 36.5 Seat 16.5



**ALLOBWD**  
Always Lounge  
on Wooden Base  
mm W 790 D 800 H 930 Seat 420  
inch W 31 D 31.5 H 36.5 Seat 16.5



**ALLOBRK**  
Always Lounge  
Rocker  
mm W 790 D 815 H 930 Seat 420  
inch W 31 D 32 H 36.5 Seat 16.5

### Base Finishes



**Steel 4 Leg**  
White / Black / Chrome



**Steel 4 Leg**  
RAL Powder Coated  
naughtone colours



**Oak / Walnut Base**



**Sled Base**  
White / Black / Chrome



**Sled Base**  
RAL Powder Coated  
naughtone Colours



**Wooden Rocker Base**

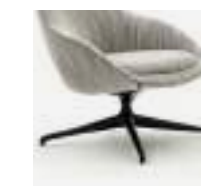

**4 Star Base**  
Black / White / Polished



**4 Star Base**  
RAL Powder Coated  
naughtone Colours

### Other Options



**Two Tone**  
Shell / Seatpad

### naughtone RAL Colours





fiji  
Chair / Sofa

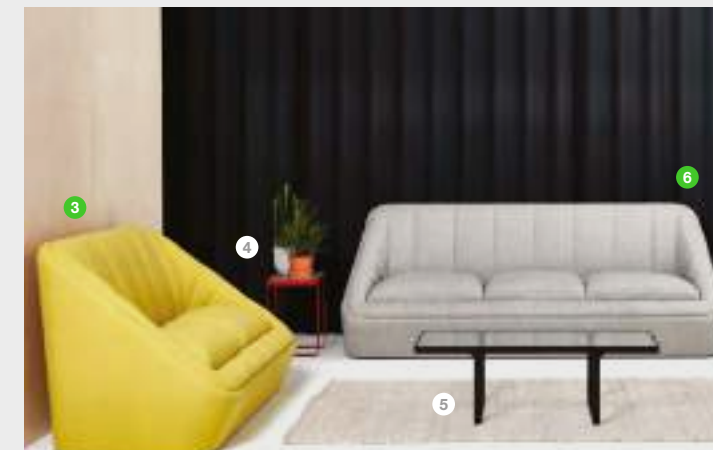

**About Fiji**

As naughtone's most luxuriously upholstered lounge chair and sofa, the Fiji range offers a significantly different aesthetic to other naughtone lounge chairs, as the plush upholstery provides a welcoming cocoon-esque retreat. The hidden swivel on Fiji chair makes it ideal for a multitude of situations.

**Compliance**

- SCS Indoor Advantage™ Gold Certificate
- naughtone is FSC® certified
- naughtone is FISP and ISO14001 certified
- Our seating is designed to meet or exceed all EN performance requirements per BS EN 16139:2013

**Sizes** All dimensions quoted are rounded to the nearest 5mm or nearest 1/2 inch



**FIJICH**  
Fiji Chair  
mm W 850 D 865 H 885 Seat 470  
inch W 33.5 D 34 H 35 Seat 18.5



**FIJICHBSW**  
Fiji Chair with Swivel  
mm W 850 D 865 H 885 Seat 470  
inch W 33.5 D 34 H 35 Seat 18.5

New



**FIJ12SF**  
Fiji 2 seat sofa  
mm W 1650 D 865 H 885 Seat 470  
inch W 65 D 34 H 35 Seat 18.5

New

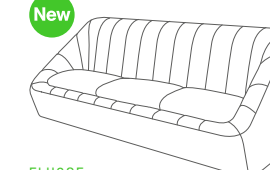

**FIJ13SF**  
Fiji 3 seat sofa  
mm W 2250 D 865 H 885 Seat 470  
inch W 88.5 D 34 H 35 Seat 18.5

**Other Options**

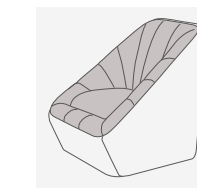

**Two Tone**  
Outer / Inner and Seat Cushion

# hush low

## Chair



### About Hush Low

Hush Low is a compact lounge chair designed with a slender shape and positive sit, making it the ideal retreat for working, reading or taking some time out. Being completely customisable, Hush Low looks fantastic in educational spaces, break out zones and reception lounges.

### Compliance

- SCS Indoor Advantage™ Gold Certificate
- naughtone is FSC® certified
- naughtone is FISP and ISO14001 certified
- Our chairs are designed to meet or exceed all EN performance requirements per BS EN 16139:2013

### Sizes

All dimensions quoted are rounded to the nearest 5mm or nearest 1/2 inch



**HULOBSL**  
Hush Low Chair  
with Sled Base  
mm  
W720 D760 H880 Seat 430  
inch  
W28.5 D30 H34.5 Seat 17



**HULOB4S**  
Hush Low Chair 4 Star Base  
with Standard Glides  
mm  
W720 D760 H880 Seat 430  
inch  
W28.5 D30 H34.5 Seat 17

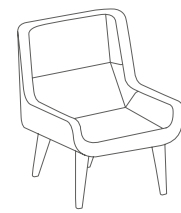

**HULOBWD**  
Hush Low Chair  
with Wooden Legs  
mm  
W720 D760 H880 Seat 430  
inch  
W28.5 D30 H34.5 Seat 17

### Base Finishes



**Sled Base**  
White / Black  
Standard



**Sled Base**  
RAL Powder Coated  
naughtone Colours



**Sled Base**  
Chrome



**4 Star Base**  
Black / White / Polished

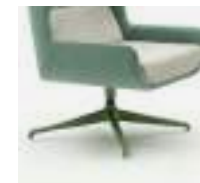

**4 Star Base**  
RAL Powder Coated  
naughtone Colours



**Turned Solid**  
Oak Legs



**Turned Solid**  
Walnut Legs

### Other Options



**Two Tone**  
Outer / Inner

# hush

Chair



### About Hush

Hush takes inspiration from the past but responds to contemporary demands. The unmistakable wing-back form offers a welcoming familiarity and sanctuary, making it an ideal retreat for working, relaxing or having private conversations in.

### Compliance

- SCS Indoor Advantage™ Gold Certificate
- naughtone is FSC® certified
- naughtone is FISP and ISO14001 certified
- Our chairs are designed to meet or exceed all EN performance requirements per BS EN 16139:2013

### Sizes

All dimensions quoted are rounded to the nearest 5mm or nearest 1/2 inch

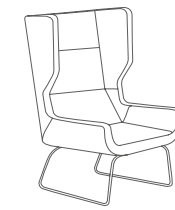

**HUSHBSL**  
Hush Chair  
with Sled Base  
mm  
W 720 D 815 H 1160 Seat 430  
inch  
W 28.5 D 32 H 45.5 Seat 17



**HUSHB4S**  
Hush Chair 4 Star Base  
with Standard Glides  
mm  
W 720 D 815 H 1160 Seat 430  
inch  
W 28.5 D 32 H 45.5 Seat 17



**HUSHBWD**  
Hush Chair  
with Wooden Legs  
mm  
W 720 D 815 H 1160 Seat 430  
inch  
W 28.5 D 32 H 45.5 Seat 17

### Base Finishes



Sled Base  
White / Black  
Standard



Sled Base  
RAL Powder Coated  
naughtone Colours



Sled Base  
Chrome



4 Star Base  
Black / White / Polished



4 Star Base  
RAL Powder Coated  
naughtone Colours



Turned Solid  
Oak Legs



Turned Solid  
Walnut Legs

### Other Options

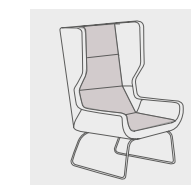

Two Tone  
Outer / Inner

### naughtone RAL Colours



# hush low

Sofa

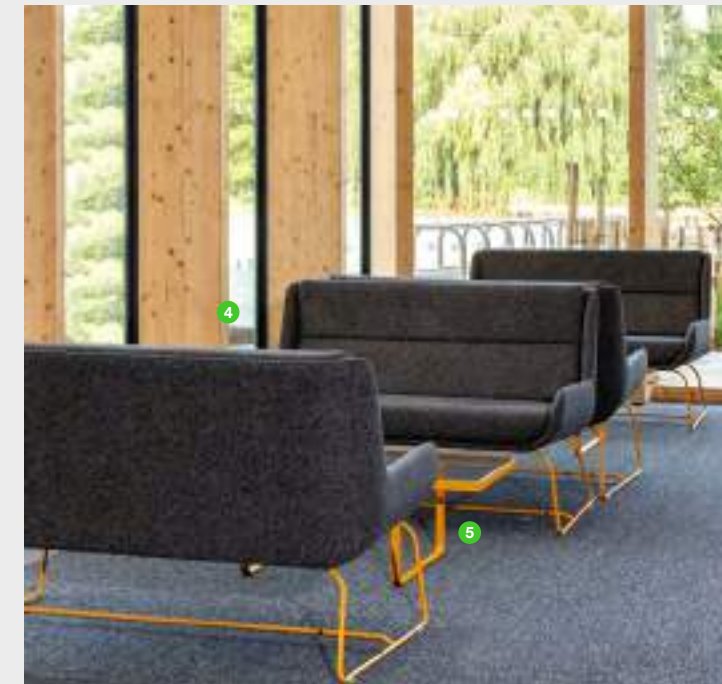

## About Hush Low Sofa

Hush Low Sofa is a compact sofa with simple, broad appeal. Being designed with an upright, positive seating position allows Hush Low Sofa to be ideally suited for reception lounges and public spaces.

## Compliance

- SCS Indoor Advantage™ Gold Certificate
- naughtone is FSC® certified
- naughtone is FISP and ISO14001 certified
- Our chairs are designed to meet or exceed all EN performance requirements per BS EN 16139:2013

## Sizes

All dimensions quoted are rounded to the nearest 5mm or nearest 1/2 inch

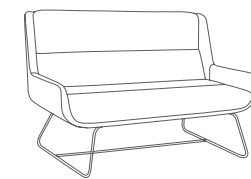

**HLO2SFBSL**  
Hush Low 2 Seat Sofa  
with Sled Base  
mm  
W 1350 D 760 H 880 Seat 430  
inch  
W 53 D 30 H 34.5 Seat 17

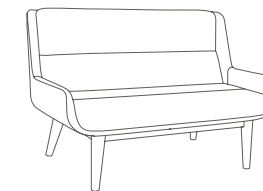

**HLO2SFBWD**  
Hush Low 2 Seat Sofa  
with Wooden Base  
mm  
W 1350 D 760 H 880 Seat 430  
inch  
W 53 D 30 H 34.5 Seat 17

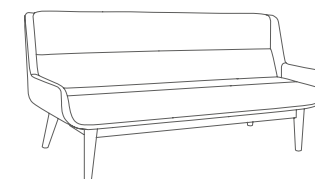

**HLO3SFBWD**  
Hush Low 3 Seat Sofa  
with Wooden Base  
mm  
W 2000 D 760 H 880 Seat 430  
inch  
W 79 D 30 H 34.5 Seat 17

## Base Finishes



Sled Base  
White / Black  
Standard



Sled Base  
RAL Powder Coated  
naughtone Colours



Sled Base  
Chrome



Turned Solid Oak  
or Walnut Legs



Turned Solid Oak  
or Walnut Legs

## Other Options

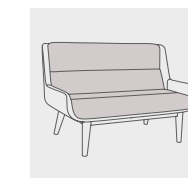

Two Tone  
Outer / Inner



# hush

Sofa



### About Hush Sofa

The Hush Sofa makes perfect sense of the distinctive Hush profile, taking on its own elegant characteristic whilst expanding on the acoustic benefits. The Hush Sofa is ideally suited for reception lounges and public spaces.

### Compliance

- SCS Indoor Advantage™ Gold Certificate
- naughtone is FSC® certified
- naughtone is FISP and ISO14001 certified
- Our chairs are designed to meet or exceed all EN performance requirements per BS EN 16139:2013

### Sizes

All dimensions quoted are rounded to the nearest 5mm or nearest 1/2 inch

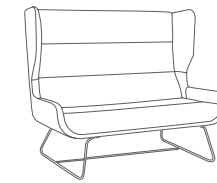

**HSH2SFBSL**  
Hush 2 Seat Sofa  
with Sled Base  
mm  
W 1350 D 815 H 1160 Seat 430  
inch  
W 53 D 32 H 45.5 Seat 17

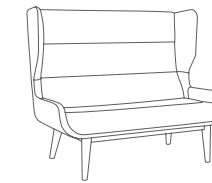

**HSH2SFBWD**  
Hush 2 Seat Sofa  
with Wooden Base  
mm  
W 1350 D 815 H 1160 Seat 430  
inch  
W 53 D 32 H 45.5 Seat 17

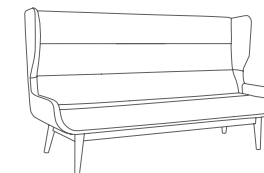

**HSH3SFBWD**  
Hush 3 Seat Sofa  
with Wooden Base  
mm  
W 2000 D 815 H 1160 Seat 430  
inch  
W 79 D 32 H 45.5 Seat 17

### Base Finishes



Sled Base  
White / Black  
Standard



Sled Base  
RAL Powder Coated  
naughtone Colours



Sled Base  
Chrome



Turned Solid Oak  
or Walnut Legs



Turned Solid Oak  
or Walnut Legs

### Other Options



Two Tone  
Outer / Inner

# cloud quilt

Armchair and Sofa



## About Cloud

The Cloud seating range is designed to be inviting and comfortable without consuming masses of space. The tactile and fully upholstered surround provides a further element of luxury whilst offering a visual and acoustic haven for individual or group work.

## Compliance

- SCS Indoor Advantage™ Gold Certificate
- naughtone is FSC® certified
- naughtone is FISP and ISO14001 certified
- Our seating is designed to meet or exceed all EN performance requirements per BS EN 16139:2013

## Sizes

All dimensions quoted are rounded to the nearest 5mm or nearest 1/2 inch

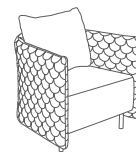

**CLOG1**  
Cloud Quilt Armchair with Low Back  
mm W 800 D 750 H 650 Seat 400  
inch W 31.5 D 29.5 H 25.5 Seat 15.5

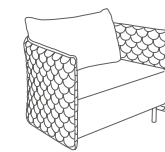

**CLOG15L**  
Cloud Quilt 1.5 Seat Sofa with Low Back  
mm W 1100 D 750 H 650 Seat 400  
inch W 43.5 D 29.5 H 25.5 Seat 15.5

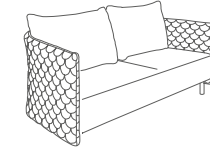

**CLOG2L**  
Cloud Quilt 2 Seat Sofa with Low Back  
mm W 1600 D 750 H 650 Seat 400  
inch W 63 D 29.5 H 25.5 Seat 15.5



**CLOG3L**  
Cloud Quilt 3 Seat Sofa with Low Back  
mm W 2100 D 750 H 650 Seat 400  
inch W 82.5 D 29.5 H 25.5 Seat 15.5

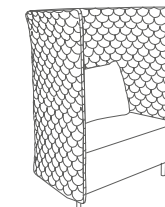

**CLOG15H**  
Cloud Quilt 1.5 Seat Sofa with High Back  
mm W 1100 D 750 H 1300 Seat 400  
inch W 43.5 D 29.5 H 51 Seat 15.5

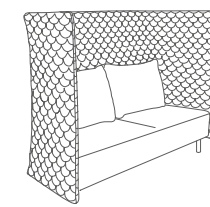

**CLOG2H**  
Cloud Quilt 2 Seat Sofa with High Back  
mm W 1600 D 750 H 1300 Seat 400  
inch W 63 D 29.5 H 51 Seat 15.5

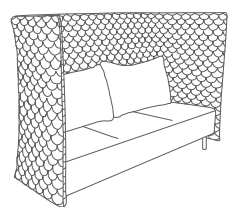

**CLOG3H**  
Cloud Quilt 3 Seat Sofa with High Back  
mm W 2100 D 750 H 1300 Seat 400  
inch W 82.5 D 29.5 H 51 Seat 15.5

## Base Options

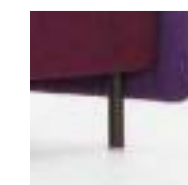

Black Powder Coated Steel Straight Legs Standard



Turned Solid Oak or Walnut Legs

## Other Options



Two Tone Outer / Seat and Cushions



# cloud plain

Armchair and Sofa



### About Cloud

The Cloud seating range is designed to be inviting and comfortable without consuming masses of space. The tactile and fully upholstered surround provides a further element of luxury whilst offering a visual and acoustic haven for individual or group work.

### Compliance

- SCS Indoor Advantage™ Gold Certificate
- naughtone is FSC® certified
- naughtone is FISP and ISO14001 certified
- Our seating is designed to meet or exceed all EN performance requirements per BS EN 16139:2013

### Sizes

All dimensions quoted are rounded to the nearest 5mm or nearest 1/2 inch

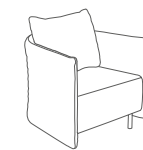

**CLOP1**  
Cloud Plain Armchair with Low Back  
mm W 800 D 750 H 650 Seat 400  
inch W 31.5 D 29.5 H 25.5 Seat 15.5

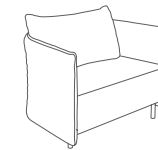

**CLOP15L**  
Cloud Plain 1.5 Seat Sofa with Low Back  
mm W 1100 D 750 H 650 Seat 400  
inch W 43.5 D 29.5 H 25.5 Seat 15.5

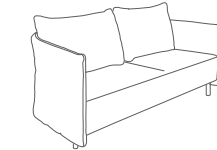

**CLOP2L**  
Cloud Plain 2 Seat Sofa with Low Back  
mm W 1600 D 750 H 650 Seat 400  
inch W 63 D 29.5 H 25.5 Seat 15.5



**CLOP3L**  
Cloud Plain 3 Seat Sofa with Low Back  
mm W 2100 D 750 H 650 Seat 400  
inch W 82.5 D 29.5 H 25.5 Seat 15.5

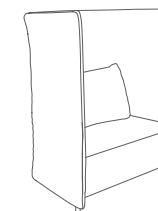

**CLOP15H**  
Cloud Plain 1.5 Seat Sofa with High Back  
mm W 1100 D 750 H 1300 Seat 400  
inch W 43.5 D 29.5 H 51 Seat 15.5

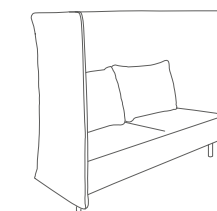

**CLOP2H**  
Cloud Plain 2 Seat Sofa with High Back  
mm W 1600 D 750 H 1300 Seat 400  
inch W 63 D 29.5 H 51 Seat 15.5

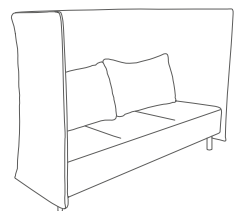

**CLOP3H**  
Cloud Plain 3 Seat Sofa with High Back  
mm W 2100 D 750 H 1300 Seat 400  
inch W 82.5 D 29.5 H 51 Seat 15.5

### Base Options

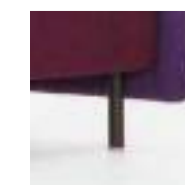

Black Powder Coated Steel Straight Legs Standard



Turned Solid Oak or Walnut Legs

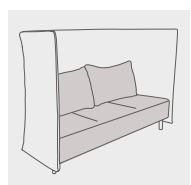

Two Tone Outer / Seat and Cushions

### Other Options

# cloud booth

Plain / Quilted



## About Cloud

The Cloud seating range is designed to be inviting and comfortable without consuming masses of space. The tactile and fully upholstered surround provides a further element of luxury whilst offering a visual and acoustic haven for individual or group work.

## Compliance

- SCS Indoor Advantage™ Gold Certificate
- naughtone is FSC® certified
- naughtone is FISP and ISO14001 certified
- Our booths are designed to meet or exceed all EN performance requirements per BS EN 16139:2013

## Sizes

All dimensions quoted are rounded to the nearest 5mm or nearest 1/2 inch

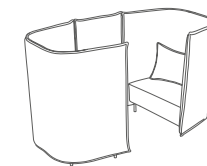

**CLOBP15**  
Cloud Plain 1.5 Seat Booth with Privacy Panel  
mm W 1100 D 2200 H 1300 Seat 400  
inch W 43.5 D 86.5 H 51 Seat 15.5

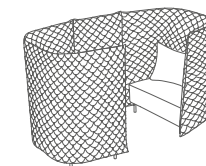

**CLOBQ15**  
Cloud Quilt 1.5 Seat Booth with Privacy Panel  
mm W 1100 D 2200 H 1300 Seat 400  
inch W 43.5 D 86.5 H 51 Seat 15.5

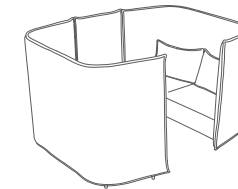

**CLOBP2**  
Cloud Plain 2 Seat Booth with Privacy Panel  
mm W 1600 D 2200 H 1300 Seat 400  
inch W 63 D 86.5 H 51 Seat 15.5

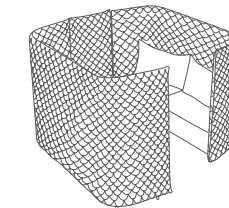

**CLOBQ2**  
Cloud Quilt 2 Seat Booth with Privacy Panel  
mm W 1600 D 2200 H 1300 Seat 400  
inch W 63 D 86.5 H 51 Seat 15.5

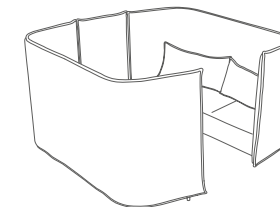

**CLOBP3**  
Cloud Plain 3 Seat Booth with Privacy Panel  
mm W 2100 D 2200 H 1300 Seat 400  
inch W 82.5 D 86.5 H 51 Seat 15.5

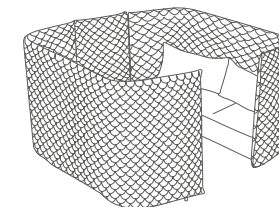

**CLOBQ3**  
Cloud Quilt 3 Seat Booth with Privacy Panel  
mm W 2100 D 2200 H 1300 Seat 400  
inch W 82.5 D 86.5 H 51 Seat 15.5

## Base Options



Black Powder Coated Steel Straight Legs Standard



Turned Solid Oak or Walnut Legs

## Other Options

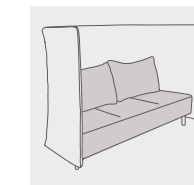

Two Tone Outer / Seat and Cushions

# cloud desk

Plain / Quilted



## About Cloud Desk

Cloud Desk is a fully upholstered booth that is a truly satisfying place to sit and concentrate. As a visual and acoustic haven, Cloud Desk offers users a comfortable and private space to work independently.



## Compliance

- SCS Indoor Advantage™ Gold Certificate
- naughtone is FSC® certified
- naughtone is FISP and ISO14001 certified
- Our desk furniture is designed to meet or exceed all EN performance requirements per BS EN 527-2:2016

## Sizes

All dimensions quoted are rounded to the nearest 5mm or nearest 1/2 inch

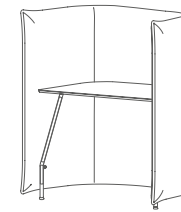

**CLODP15H**  
Cloud 1.5 Desk  
with High Plain Back  
mm  
W 1100 D 750 H 1300  
Table height 750  
inch  
W 43.5 D 29.5 H 51  
Table height 29.5

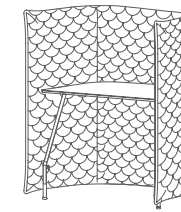

**CLODQ15H**  
Cloud 1.5 Desk  
with High Quilted Back  
mm  
W 1100 D 750 H 1300  
Table height 750  
inch  
W 43.5 D 29.5 H 51  
Table height 29.5

## Top Options



**White / Black MFMDF**  
with reverse chamfer,  
polished MDF edge



**Oak Veneer**  
with reverse chamfer,  
polished MDF edge



**Walnut Veneer**  
with reverse chamfer,  
polished MDF edge



**Forbo Lino**  
with reverse chamfer edge  
8 colours available

## Leg Finishes

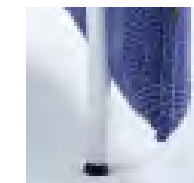

**White Powder Coated**  
Standard

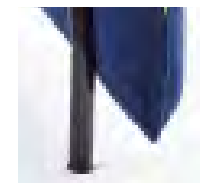

**Black Powder Coated**  
Standard

# pullman New

## Booth



### About Pullman

Taking its name from the old train carriages, Pullman is a luxurious and private collaboration space developed with AV integration in mind. Pullman is an acoustic haven and has discrete cable management built in, making it ideal for breakout, small meetings or individual working.

### Compliance

- SCS Indoor Advantage™ Gold Certificate
- naughtone is FSC® certified
- naughtone is FISP and ISO14001 certified
- Our seating is designed to meet or exceed all EN performance requirements per BS EN 16139:2013

### Sizes

All dimensions quoted are rounded to the nearest 5mm or nearest 1/2 inch

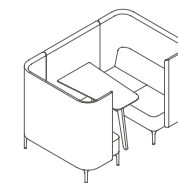

**PULB2H**  
Pullman 2 Seat Booth  
mm W 1950 D 1200 H 1300 Seat 450  
inch W 77 D 47 H 51 Seat 18

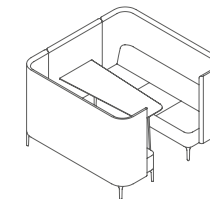

**PULB3H**  
Pullman 3 Seat Booth  
mm W 1950 D 1900 H 1300 Seat 450  
inch W 77 D 75 H 51 Seat 18

### Table Top Options



**White / Black MFMD**  
edge banded



**White / Black MFMD**  
with reverse chamfer,  
polished MDF edge



**Forbo Lino**  
with reverse chamfer edge  
8 colours available



**Oak Veneer**  
with reverse chamfer,  
polished MDF edge



**Walnut Veneer**  
with reverse chamfer,  
polished MDF edge

### Accessories



**Magnetic White Board**  
accessory supplied with magnets

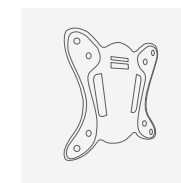

**TV Mounting Bracket**  
to fit 13" to 27" screen  
(TV not included)



**Panda Power and Data**

### Base Finishes



**White / Black Steel Legs**  
Standard



**RAL Powder Coated Legs**  
naughtone Colours



**Solid Oak Legs**



**Solid Walnut Legs**

### Other Options

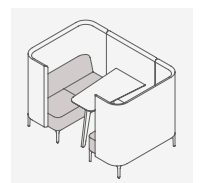

**Two Tone**  
Seat / All Sides



hue **New**  
Seating



**About Hue**

Hue is designed for dividing, creating and utilising awkward space whilst encouraging collaboration at a higher posture. As a luxurious retreat for group or individual work, Hue is perfect for use in narrow spaces, and is ideally suited for pre and post meeting situations.



Available to order September 2019

**Compliance**

- SCS Indoor Advantage™ Gold Certificate
- naughtone is FSC® certified
- naughtone is FISP and ISO14001 certified

**Sizes** All dimensions quoted are rounded to the nearest 5mm or nearest 1/2 inch

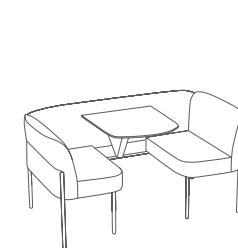

**HUEST**  
Hue with Steel Legs  
mm W 1870 D 900 H 750 Seat 450  
inch W 73.5 D 35.5 H 29.5 Seat 18

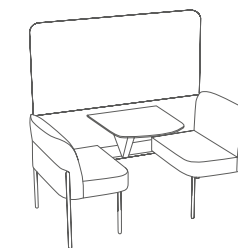

**HUESST**  
Hue with Screen and Steel Legs  
mm W 1870 D 900 H 1495 Seat 450  
inch W 73.5 D 35.5 H 59 Seat 18

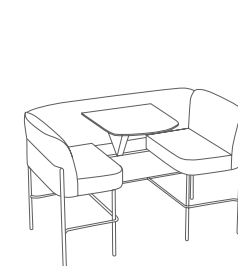

**HUEBHST**  
Hue Bar Height with Steel Legs  
mm W 1870 D 900 H 1050 Seat 750  
inch W 73.5 D 35.5 H 41.5 Seat 29.5

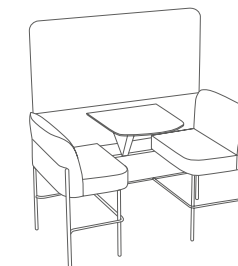

**HUEBHSST**  
Hue Bar Height with Screen and Steel Legs  
mm W 1870 D 900 H 1795 Seat 750  
inch W 73.5 D 35.5 H 70.5 Seat 29.5

**Table Top Options**



**White / Black MFMD**  
with reverse chamfer, polished MDF edge



**Oak Veneer**  
with reverse chamfer, polished MDF edge



**Walnut Veneer**  
with reverse chamfer, polished MDF edge

**Leg Finishes**



**White / Black Steel Legs**  
Standard



**RAL Powder Coated Legs**  
naughtone Colours

**Other Options**

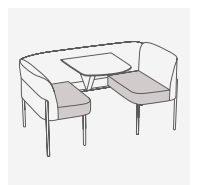

**Two Tone**  
Back and Screen / Seat Cushion



**Product Updates**  
View or download the latest product options and finishes from [www.naughtone.com/products](http://www.naughtone.com/products)



# busby

Chair

### About Busby

Busby is a modern cocoon for everyday situations, working particularly well as a haven for employees in open plan work spaces, or for users to take private phone calls within a reception lounge.



### Compliance

- SCS Indoor Advantage™ Gold Certificate
- naughtone is FSC® certified
- naughtone is FISP and ISO14001 certified
- Our chairs are designed to meet or exceed all EN performance requirements per BS EN 16139:2013

### Sizes All dimensions quoted are rounded to the nearest 5mm or nearest 1/2 inch

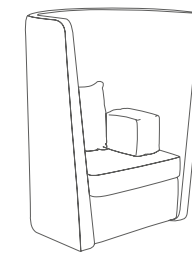

**BUSL**  
Busby Chair Left Hand  
with Cushions  
mm  
W850 D650 H1300 Seat 430  
inch  
W33.5 D25.5 H51 Seat 17



**BUSR**  
Busby Chair Right Hand  
with Cushions  
mm  
W850 D650 H1300 Seat 430  
inch  
W33.5 D25.5 H51 Seat 17

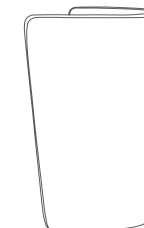
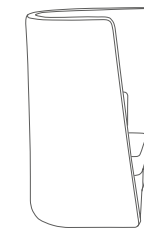

### Other Options

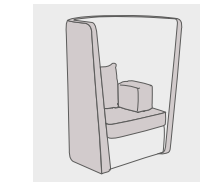

**Two Tone**  
Outer Seat and Cushions /  
Inner and Front Panel





# portion

Chair, Sofa and Bench



## About Portion

naughtone's classic sofa system is characterised by the buttoned seat and scooped back. With a unique modular twist on the classic sofa style, Portion is fully customisable, working perfectly in the workplace, hospitality and educational spaces.

## Compliance

- SCS Indoor Advantage™ Gold Certificate
- naughtone is FSC® certified
- naughtone is FISP and ISO14001 certified
- Our seating is designed to meet or exceed all EN performance requirements per BS EN 16139:2013

## Sizes

All dimensions quoted are rounded to the nearest 5mm or nearest 1/2 inch

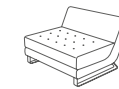

**POR1NA**  
Portion Chair no arms  
mm  
W900 D870 H610 Seat 355  
inch  
W35.5 D34 H24 Seat 14



**POR1RA**  
Portion Chair right arm  
mm  
W1100 D870 H610 Seat 355  
inch  
W43.5 D34 H24 Seat 14



**POR1LA**  
Portion Chair left arm  
mm  
W1100 D870 H610 Seat 355  
inch  
W43.5 D34 H24 Seat 14



**POR12A**  
Portion Chair 2 arms  
mm  
W1300 D870 H610 Seat 355  
inch  
W51 D34 H24 Seat 14

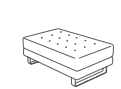

**POR1ST**  
Portion Single Stool  
mm  
W900 D630 H355 Seat 355  
inch  
W35.5 D25 H14 Seat 14



**POR2NA**  
Portion Sofa 2 Seat no arms  
mm  
W1200 D870 H610 Seat 355  
inch  
W47 D34 H24 Seat 14



**POR2RA**  
Portion Sofa 2 Seat right arm  
mm  
W1200 D870 H610 Seat 355  
inch  
W47 D34 H24 Seat 14



**POR2LA**  
Portion Sofa 2 Seat left arm  
mm  
W1400 D870 H610 Seat 355  
inch  
W55 D34 H24 Seat 14



**POR22A**  
Portion Sofa 2 Seat 2 arms  
mm  
W1600 D870 H610 Seat 355  
inch  
W63 D34 H24 Seat 14



**POR2BEN**  
Portion 2 Seat Bench  
mm  
W1200 D630 H355 Seat 355  
inch  
W47 D25 H14 Seat 14

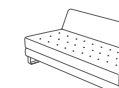

**POR3NA**  
Portion Sofa 3 Seat no arms  
mm  
W1800 D870 H610 Seat 355  
inch  
W71 D34 H24 Seat 14

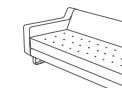

**POR3RA**  
Portion Sofa 3 Seat right arm  
mm  
W2000 D870 H610 Seat 355  
inch  
W78.5 D34 H24 Seat 14

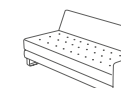

**POR3LA**  
Portion Sofa 3 Seat left arm  
mm  
W2000 D870 H610 Seat 355  
inch  
W78.5 D34 H24 Seat 14



**POR32A**  
Portion Sofa 3 Seat 2 arms  
mm  
W2200 D870 H610 Seat 355  
inch  
W86.5 D34 H24 Seat 14

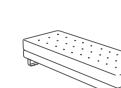

**POR3BEN**  
Portion 3 Seat Bench  
mm  
W1800 D630 H355 Seat 355  
inch  
W71 D25 H14 Seat 14



**PORCHR**  
Portion Chaise right arm  
mm  
W950 D1345 H610 Seat 355  
inch  
W37.5 D53 H24 Seat 14



**PORCHL**  
Portion Chaise left arm  
mm  
W950 D1345 H610 Seat 355  
inch  
W37.5 D53 H24 Seat 14

## Base Options



Brushed Stainless Steel Base Standard



Turned Solid Oak or Walnut Legs

## Other Options



Contrast Button Colours

# hatch

## Modular Seating



### About Hatch

Hatch is designed to be effortless to plan into configurations with its straightforward yet characteristic quilted seat modules. The tactile structure to the fabric provides a satisfying repeat pattern that works across any composition. Hatch has a firm, upright sit and compact dimensions, making it the ideal choice for modern commercial environments such as shops, restaurants or reception lounges.

### Compliance

- SCS Indoor Advantage™ Gold Certificate
- naughtone is FSC® certified
- naughtone is FISP and ISO14001 certified
- Our seating is designed to meet or exceed all EN performance requirements per BS EN 16139:2013

### Sizes

All dimensions quoted are rounded to the nearest 5mm or nearest 1/2 inch



**HAT1ST**  
Hatch Single Stool  
mm  
W510 D510 H410 Seat 410  
inch  
W20 D20 H16 Seat 16

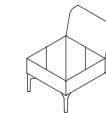

**HAT1NA**  
Hatch Chair no arms  
mm  
W510 D690 H685 Seat 410  
inch  
W20 D27 H27 Seat 16

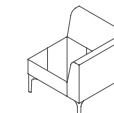

**HAT11A**  
Hatch Corner Chair 1 arm  
mm  
W690 D690 H685 Seat 410  
inch  
W27 D27 H27 Seat 16

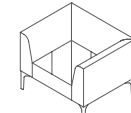

**HAT12A**  
Hatch Chair 2 arms  
mm  
W870 D690 H685 Seat 410  
inch  
W34.5 D27 H27 Seat 16

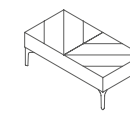

**HAT2BEN**  
Hatch 2 Seat Bench  
mm  
W1020 D510 H410 Seat 410  
inch  
W40 D20 H16 Seat 16

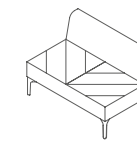

**HAT2NA**  
Hatch 2 Seater no arms  
mm  
W1020 D690 H685 Seat 410  
inch  
W40 D27 H27 Seat 16

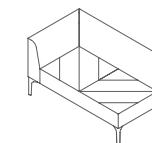

**HAT2RA**  
Hatch 2 Seater right arm  
mm  
W1200 D690 H685 Seat 410  
inch  
W47 D27 H27 Seat 16

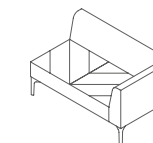

**HAT2LA**  
Hatch 2 Seater left arm  
mm  
W1200 D690 H685 Seat 410  
inch  
W47 D27 H27 Seat 16

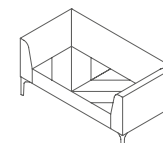

**HAT22A**  
Hatch 2 Seater 2 arms  
mm  
W1380 D690 H685 Seat 410  
inch  
W54.5 D27 H27 Seat 16

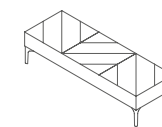

**HAT3BEN**  
Hatch 3 Seat Bench  
mm  
W1530 D510 H410 Seat 410  
inch  
W60 D20 H16 Seat 16

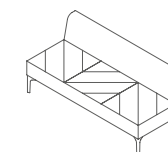

**HAT3NA**  
Hatch 3 Seater no arms  
mm  
W1530 D690 H685 Seat 410  
inch  
W60 D27 H27 Seat 16

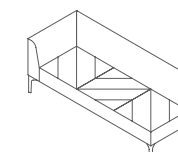

**HAT3RA**  
Hatch 3 Seater right arm  
mm  
W1710 D690 H685 Seat 410  
inch  
W67.5 D27 H27 Seat 16

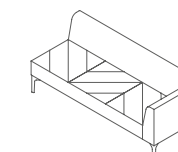

**HAT3LA**  
Hatch 3 Seater left arm  
mm  
W1710 D690 H685 Seat 410  
inch  
W67.5 D27 H27 Seat 16

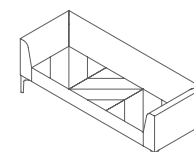

**HAT32A**  
Hatch 3 Seater 2 arms  
mm  
W1890 D690 H685 Seat 410  
inch  
W74.5 D27 H27 Seat 16

### Base Options



White Steel Legs  
Standard



Black Steel Legs  
Standard



RAL Powder Coated Legs  
naughtone Colours



Solid Oak Legs



Solid Walnut Legs

### Other Options

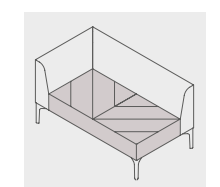

Two Tone  
Backrest and Arms / Seat

# symbol

## Modular Seating

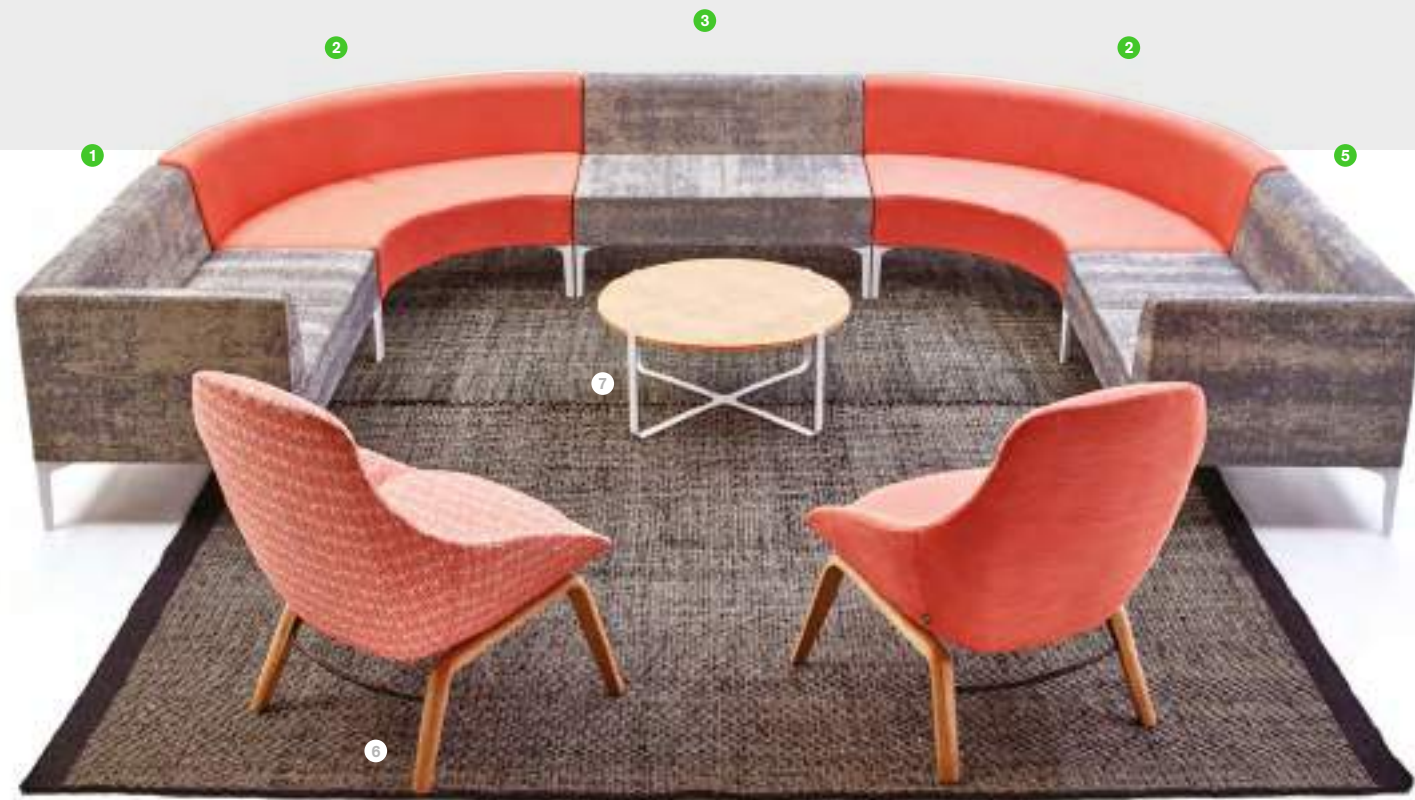

### About Symbol

The Symbol seating range has a pared down aesthetic, designed to feel like part of the architecture and provide building blocks for furniture landscapes. Symbol has a firm upright sit and compact dimensions, making it perfect for modern commercial environments where space is at a premium.

### Compliance

- SCS Indoor Advantage™ Gold Certificate
- naughtone is FSC® certified
- naughtone is FISP and ISO14001 certified
- Our seating is designed to meet or exceed all EN performance requirements per BS EN 16139:2013

### Sizes

All dimensions quoted are rounded to the nearest 5mm or nearest 1/2 inch



**SYM1ST**  
**Symbol Single Stool**  
 mm  
 W510 D510 H410 Seat 410  
 inch  
 W20 D20 H16 Seat 16

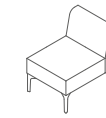

**SYM1NA**  
**Symbol Chair no arms**  
 mm  
 W510 D690 H685 Seat 410  
 inch  
 W20 D27 H27 Seat 16

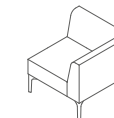

**SYM11A**  
**Symbol Corner Chair 1 arm**  
 mm  
 W690 D690 H685 Seat 410  
 inch  
 W27 D27 H27 Seat 16

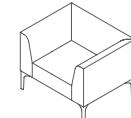

**SYM12A**  
**Symbol Chair 2 arms**  
 mm  
 W870 D690 H685 Seat 410  
 inch  
 W34.5 D27 H27 Seat 16

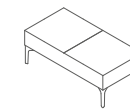

**SYM2BEN**  
**Symbol 2 Seat Bench**  
 mm  
 W1020 D510 H410 Seat 410  
 inch  
 W40 D20 H16 Seat 16

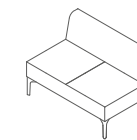

**SYM2NA**  
**Symbol 2 Seater no arms**  
 mm  
 W1020 D690 H685 Seat 410  
 inch  
 W40 D27 H27 Seat 16

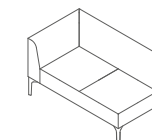

**SYM2RA**  
**Symbol 2 Seater right arm**  
 mm  
 W1200 D690 H685 Seat 410  
 inch  
 W47 D27 H27 Seat 16

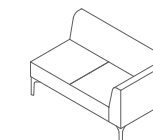

**SYM2LA**  
**Symbol 2 Seater left arm**  
 mm  
 W1200 D690 H685 Seat 410  
 inch  
 W47 D27 H27 Seat 16

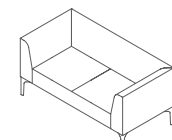

**SYM22A**  
**Symbol 2 Seater 2 arms**  
 mm  
 W1380 D690 H685 Seat 410  
 inch  
 W54.5 D27 H27 Seat 16

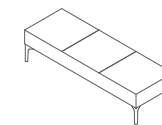

**HAT3BEN**  
**Symbol 3 Seat Bench**  
 mm  
 W1530 D510 H410 Seat 410  
 inch  
 W60 D20 H16 Seat 16

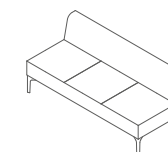

**HAT3NA**  
**Symbol 3 Seater no arms**  
 mm  
 W1530 D690 H685 Seat 410  
 inch  
 W60 D27 H27 Seat 16

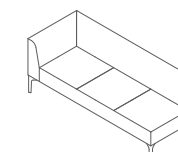

**HAT3RA**  
**Symbol 3 Seater right arm**  
 mm  
 W1710 D690 H685 Seat 410  
 inch  
 W67.5 D27 H27 Seat 16

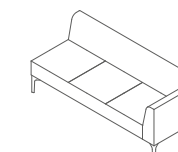

**HAT3LA**  
**Symbol 3 Seater left arm**  
 mm  
 W1710 D690 H685 Seat 410  
 inch  
 W67.5 D27 H27 Seat 16

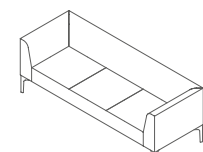

**HAT32A**  
**Symbol 3 Seater 2 arms**  
 mm  
 W1890 D690 H685 Seat 410  
 inch  
 W74.5 D27 H27 Seat 16

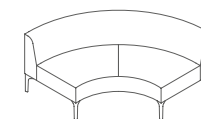

**SYM90D**  
**Symbol 90° Curve Sofa**  
 mm  
 W1825 D865 H685 Seat 410  
 inch  
 W72 D34 H27 Seat 16

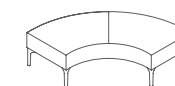

**SYM90BEN**  
**Symbol 90° Curve Bench**  
 mm  
 W1570 D685 H410 Seat 410  
 inch  
 W62 D27 H16 Seat 16

### Base Options



White / Black Steel Legs  
 Standard



RAL Powder Coated Legs  
 naughtone Colours

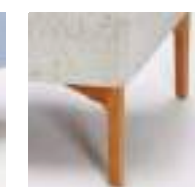

Solid Oak / Walnut Legs

### Other Options

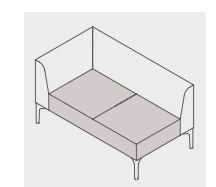

Two Tone  
 Backrest and Arms / Seat



# clyde club

Chair, Sofa and Bench

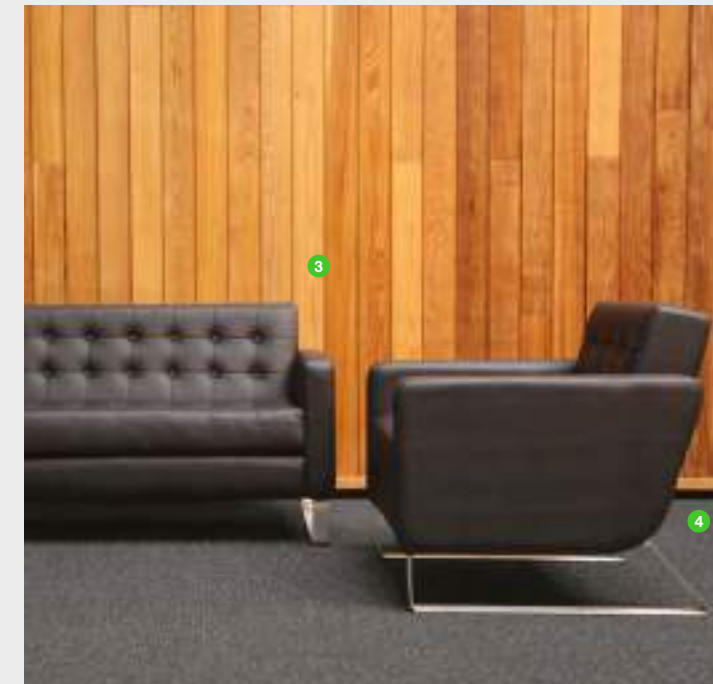

## About Clyde Club

Designed with classic functions in mind, The Clyde Club oozes familiarity whilst the scooped profile and stainless-steel sled base retain its unique contemporary edge. Clyde has a comfortable but formal sit, ideal for hospitality and retail environments, whilst the compact footprint rounds off its practical benefits.

## Compliance

- SCS Indoor Advantage™ Gold Certificate
- naughtone is FSC® certified
- naughtone is FISP and ISO14001 certified
- Our seating is designed to meet or exceed all EN performance requirements per BS EN 16139:2013

## Sizes

All dimensions quoted are rounded to the nearest 5mm or nearest 1/2 inch



**CLY1NA**  
Clyde Club Chair  
with No Arms  
mm  
W 520 D 790 H 760 Seat 420  
inch  
W 20.5 D 31 H 30 Seat 16.5



**CLY12A**  
Clyde Club Chair  
with 2 Arms  
mm  
W 700 D 790 H 760 Seat 420  
inch  
W 27.5 D 31 H 30 Seat 16.5



**CLY1ST**  
Clyde Club  
Single Stool  
mm  
W 900 D 550 H 420 Seat 420  
inch  
W 35.4 D 21.5 H 16.5 Seat 16.5



**CLY2NA**  
Clyde Club 2 Seat Sofa  
with No Arms  
mm  
W 1200 D 790 H 760 Seat 420  
inch  
W 47 D 31 H 30 Seat 16.5



**CLY2RA**  
Clyde Club 2 Seat Sofa  
with Right Arm  
mm  
W 1280 D 790 H 760 Seat 420  
inch  
W 50.5 D 31 H 30 Seat 16.5



**CLY2LA**  
Clyde Club 2 Seat Sofa  
with Left Arm  
mm  
W 1280 D 790 H 760 Seat 420  
inch  
W 50.5 D 31 H 30 Seat 16.5

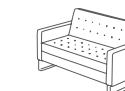

**CLY22A**  
Clyde Club 2 Seat Sofa  
with 2 Arms  
mm  
W 1360 D 790 H 760 Seat 420  
inch  
W 53.5 D 31 H 30 Seat 16.5

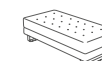

**CLY2BEN**  
Clyde Club  
2 Seat Bench  
mm  
W 1200 D 550 H 420 Seat 420  
inch  
W 47 D 21.5 H 16.5 Seat 16.5



**CLY3NA**  
Clyde Club 3 Seat Sofa  
with No Arms  
mm  
W 1800 D 790 H 760 Seat 420  
inch  
W 71 D 31 H 30 Seat 16.5

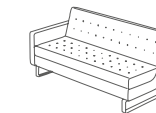

**CLY3RA**  
Clyde Club 3 Seat Sofa  
with Right Arm  
mm  
W 1880 D 790 H 760 Seat 420  
inch  
W 74 D 31 H 30 Seat 16.5

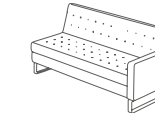

**CLY3LA**  
Clyde Club 3 Seat Sofa  
with Left Arm  
mm  
W 1880 D 790 H 760 Seat 420  
inch  
W 74 D 31 H 30 Seat 16.5

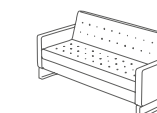

**CLY32A**  
Clyde Club 3 Seat Sofa  
with 2 Arms  
mm  
W 1960 D 790 H 760 Seat 420  
inch  
W 77 D 31 H 30 Seat 16.5

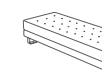

**CLY3BEN**  
Clyde Club  
3 Seat Bench  
mm  
W 1800 D 550 H 420 Seat 420  
inch  
W 71 D 21.5 H 16.5 Seat 16.5

## Base Options



Brushed Stainless  
Steel Base  
Standard



Turned Solid Oak  
or Walnut Legs



Contrast Button Colours



# rhyme

## Modular Seating



### About Rhyme

Rhyme is a modular seating system that transforms the landscape within an atrium, creating ad-hoc zones or being used as an island, making it a striking choice for educational spaces, shopping centres or large public areas. Each of the five pieces within the range are fully upholstered, with the same trapezoid footprint to allow for easy planning.

### Compliance

- SCS Indoor Advantage™ Gold Certificate
- naughtone is FSC® certified
- naughtone is FISP and ISO14001 certified
- Our seating is designed to meet or exceed all EN performance requirements per BS EN 16139:2013

### Sizes

All dimensions quoted are rounded to the nearest 5mm or nearest 1/2 inch



**RYMBEN**  
Rhyme Bench  
mm  
W 1400 D 1400 H 420 Seat 420  
inch  
W 55 D 55 H 16.5 Seat 16.5

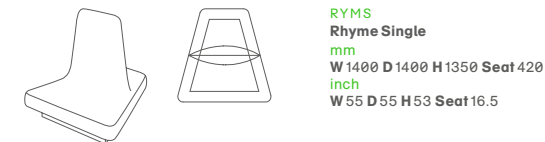

**RYMS**  
Rhyme Single  
mm  
W 1400 D 1400 H 1350 Seat 420  
inch  
W 55 D 55 H 53 Seat 16.5

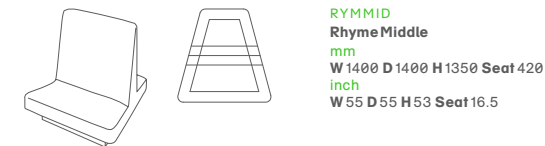

**RYMMID**  
Rhyme Middle  
mm  
W 1400 D 1400 H 1350 Seat 420  
inch  
W 55 D 55 H 53 Seat 16.5

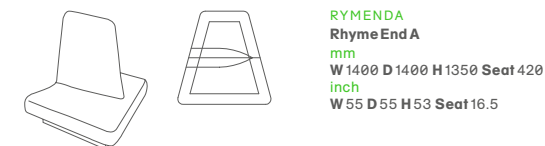

**RYMENDA**  
Rhyme End A  
mm  
W 1400 D 1400 H 1350 Seat 420  
inch  
W 55 D 55 H 53 Seat 16.5

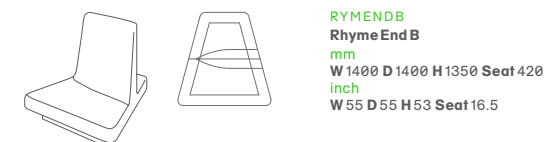

**RYMENDB**  
Rhyme End B  
mm  
W 1400 D 1400 H 1350 Seat 420  
inch  
W 55 D 55 H 53 Seat 16.5

### Plinth Finishes



Black / White Powder Coated Plinth Standard



RAL Powder Coated Plinth naughtone Colours



Plinth Infill Panel to match Plinth colour

### Other Options

### Example

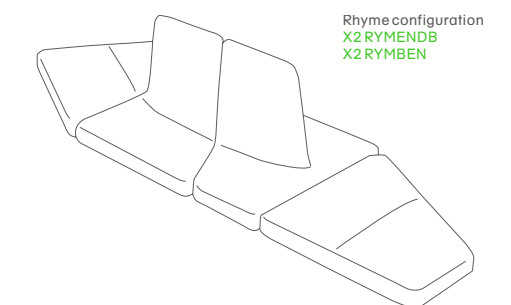

# thankyou

Issue 5.0

This brochure is thanks to the hard work of our clients and customers. Without their fresh approach to interiors we would not have had cause to develop exciting new products.

Also, thanks to the naughtone team for all their hard work and all of our friends who have contributed toward the content in this brochure.

## **UK Showroom**

6 Bakers Yard  
Clerkenwell  
London EC1R 3DD  
T: +44 (0)20 389 22 788

## **US Showroom**

Suite 10-110  
222 Merchandise Mart Plaza  
Floor 10  
Chicago IL 60654

## **naughtone HQ**

Knaresborough Tech Park  
Manse Lane  
Knaresborough HG5 8LF

T: +44 (0) 1423 816 500  
E: sales@naughtone.com

[www.naughtone.com](http://www.naughtone.com)

